

Cosentyx®

Interleukin inhibitors.

DESCRIPTION AND COMPOSITION**Pharmaceutical Forms****Solution for injection in a single dose pre-filled syringe**

The solution is colorless to slightly yellow.

Solution for injection in a pre-filled pen

The solution is colorless to slightly yellow.

Certain dosage strengths and dosage forms may not be available in all countries.

Active substance

Each 2 mL pre-filled syringe or pre-filled pen contains 300 mg secukinumab

Each 1 mL pre-filled syringe or pre-filled pen contains 150 mg secukinumab.

Each 0.5 mL pre-filled syringe contains 75 mg secukinumab.

Secukinumab is a recombinant fully human monoclonal antibody selective for interleukin-17A.

Secukinumab is of the IgG1/ κ -class produced in Chinese Hamster Ovary (CHO) cells.

Excipients

Solution for injection (pre-filled syringe and pre-filled pen): Trehalose dihydrate, L-histidine/histidine hydrochloride monohydrate, L-methionine, polysorbate 80, water for injection.

INDICATIONS**Plaque psoriasis**

Cosentyx is indicated for the treatment of moderate to severe plaque psoriasis in patients 6 years and older who are candidates for systemic therapy or phototherapy (See section CLINICAL STUDIES)

Psoriatic arthritis

Cosentyx is indicated for the treatment of active psoriatic arthritis in adult patients when the

response to previous disease-modifying anti-rheumatic drug (DMARD) therapy has been inadequate. Cosentyx can be used alone or in combination with methotrexate.

Axial spondyloarthritis (axSpA) with or without radiographic damage

Ankylosing spondylitis (AS)/ axSpA with radiographic damage

Cosentyx is indicated for the treatment of active ankylosing spondylitis in adult patients who have responded inadequately to conventional therapy.

Non-radiographic axial spondyloarthritis (nr-axSpA) / axSpA without radiographic damage

Cosentyx is indicated for the treatment of adult patients with active non-radiographic axial spondyloarthritis with objective signs of inflammation, as indicated by elevated C-reactive protein (CRP) and/or magnetic resonance imaging (MRI) evidence who have had an inadequate response to, or are intolerant to nonsteroidal anti-inflammatory drugs (NSAIDs).

Juvenile Idiopathic Arthritis (JIA)

Enthesitis-Related Arthritis (ERA)

Cosentyx is indicated for the treatment of active enthesitis-related arthritis in patients 6 years and older whose disease has responded inadequately to, or who cannot tolerate, conventional therapy (see CLINICAL TRIAL section).

Juvenile Psoriatic Arthritis (JPsA)

Cosentyx is indicated for the treatment of active juvenile psoriatic arthritis in patients 6 years and older whose disease has responded inadequately to, or who cannot tolerate, conventional therapy (see CLINICAL TRIAL section).

Hidradenitis Suppurativa (HS)

Cosentyx is indicated for the treatment of moderate to severe hidradenitis suppurativa (acne inversa) in adult patients with an inadequate response to conventional systemic therapy (See clinical trials section).

DOSAGE REGIMEN AND ADMINISTRATION

Dosage regimen

Plaque psoriasis

Adult patients

The recommended dose is 300 mg by subcutaneous injection with initial dosing at Weeks 0, 1, 2, 3, and 4 followed by monthly maintenance dosing. Based on clinical response, a maintenance dose of 300 mg every 2 weeks may provide additional benefit for patients with a body weight of 90 kg or higher.

Each 300 mg dose is given as one subcutaneous injection of 300mg or as two subcutaneous injections of 150 mg.

For some patients, a dosage of 150 mg may be acceptable.

Pediatric patients

The recommended dose is based on body weight (Table 1) and administered by subcutaneous injection with initial dosing at Weeks 0, 1, 2, 3, and 4 followed by monthly maintenance dosing (every 4 weeks). Each 75 mg dose is given as one subcutaneous injection of 75 mg. Each 150 mg dose is given as one subcutaneous injection of 150 mg. Each 300 mg dose is given as one subcutaneous injection of 300 mg or as two subcutaneous injections of 150 mg.

Table 1 Recommended dose of Cosentyx for pediatric plaque psoriasis

Body weight at time of dosing	Recommended Dose
<25 kg	75 mg
25 to <50 kg	75 mg
≥50 kg	150 mg (*may be increased to 300 mg)

**Some patients may derive additional benefit from the higher dose.*

Psoriatic arthritis

The recommended dose is 150 mg by subcutaneous injection with initial dosing at Weeks 0, 1, 2, 3, and 4 followed by monthly maintenance dosing. Based on clinical response, the dose can be increased to 300 mg.

For patients with concomitant moderate to severe plaque psoriasis, the dosage and administration for adult plaque psoriasis is recommended.

For patients who are anti-TNF-alpha inadequate responders (IR), the recommended dose is 300 mg by subcutaneous injection with initial dosing at Weeks 0, 1, 2, 3, and 4 followed by monthly maintenance dosing.

Each 300 mg dose is given as one subcutaneous injection of 300mg or as two subcutaneous injections of 150 mg.

Ankylosing spondylitis (AS)

The recommended dose is 150 mg by subcutaneous injection with initial dosing at Weeks 0, 1, 2, 3, and 4 followed by monthly maintenance dosing. Based on clinical response, the dose can be increased to 300 mg.

Each 300 mg dose is given as one subcutaneous injection of 300mg or as two subcutaneous injections of 150 mg.

For all the above indications, available data suggest that a clinical response is usually achieved within 16 weeks of treatment. Consideration should be given to discontinuing treatment in patients who have shown no response by 16 weeks of treatment. Some patients with an initial partial response may subsequently improve with continued treatment beyond 16 weeks.

Non-radiographic axial spondyloarthritis (nr-axSpA)

The recommended dose is 150 mg by subcutaneous injection with initial dosing at Weeks 0, 1, 2, 3, and 4 followed by monthly maintenance dosing.

Juvenile Idiopathic Arthritis (JIA)

Enthesitis-Related Arthritis (ERA) and Juvenile Psoriatic Arthritis (JPsA)

The recommended dose is based on body weight. For patients weighing < 50 kg the dose is 75 mg. For patients weighing \geq 50 kg the dose is 150 mg. Cosentyx is administered by subcutaneous injection at Weeks 0, 1, 2, 3, and 4 followed by monthly maintenance dosing (every 4 weeks). Each 75 mg dose is given as one subcutaneous injection of 75 mg. Each 150 mg dose is given as one subcutaneous injection of 150 mg.

COSENTYX may be administered with or without methotrexate.

Hidradenitis Suppurativa

The recommended dose is 300 mg of secukinumab by subcutaneous injection with initial dosing at Weeks 0, 1, 2, 3 and 4, followed by monthly maintenance dosing. Based on clinical response, the maintenance dose can be increased to 300 mg every 2 weeks.

Each 300 mg dose is given as one subcutaneous injection of 300 mg or as two subcutaneous injections of 150 mg.

Special populations

Renal impairment / hepatic impairment

Cosentyx has not been studied specifically in these patient populations.

Pediatric patients

Limited data in pediatric patients with the JIA categories of ERA and JPsA below the age of 6 years.

Safety and effectiveness of pediatric patients with plaque psoriasis below the age of 6 years have not been established.

Safety and effectiveness in pediatric patients below the age of 18 years in other indications have not yet been established.

Geriatric patients (65 years or above)

No dose adjustment is required.

Method of administration

Pre-filled syringe & pre-filled pen

Cosentyx is administered by subcutaneous injection. If possible, areas of the skin that show psoriasis should be avoided as injection sites.

After proper training in subcutaneous injection technique, patients may self-inject Cosentyx or be injected by a caregiver if a physician determines that it is appropriate. However, the physician should ensure appropriate follow-up of patients.

Patients and/or caregivers should be instructed to inject the full amount of Cosentyx according to the instructions provided in the package leaflet. Comprehensive instructions for administration are given in the package leaflet.

For patients receiving the 75 mg dose, the 75 mg/0.5 mL pre-filled syringe should be used.

Full instructions for use are provided in section PHARMACEUTICAL INFORMATION.

CONTRAINDICATIONS

Severe hypersensitivity reactions to the active substance or to any of the excipients (see sections DESCRIPTION AND COMPOSITION, WARNINGS AND PRECAUTIONS and ADVERSE DRUG REACTIONS).

WARNINGS AND PRECAUTIONS

Infections

Cosentyx has the potential to increase the risk of infections. In clinical studies, infections have been observed in patients receiving Cosentyx (see section ADVERSE DRUG REACTIONS). Most of these were mild or moderate upper respiratory tract infections such as nasopharyngitis and did not require treatment discontinuation.

Caution should be exercised when considering the use of Cosentyx in patients with a chronic infection or a history of recurrent infection.

Patients should be instructed to seek medical advice if signs or symptoms suggestive of an infection occur. If a patient develops a serious infection, the patient should be closely monitored and Cosentyx should not be administered until the infection resolves.

No increased susceptibility to tuberculosis was reported from clinical studies. However, Cosentyx should not be given to patients with active tuberculosis. Anti-tuberculosis therapy should be considered prior to initiation of Cosentyx in patients with latent tuberculosis.

Inflammatory Bowel Disease (IBD)

Caution should be exercised, when prescribing Cosentyx to patients with inflammatory bowel disease (e.g., Crohn's disease and ulcerative colitis) as exacerbations of IBD, in some cases serious, were observed in clinical studies in both Cosentyx and placebo groups.

In addition, cases of new onset IBD have been reported with post-marketing use.

Patients who are treated with Cosentyx and have IBD should be followed closely.

Hypersensitivity reactions

In clinical studies, rare cases of anaphylactic reactions and angioedema have been observed in patients receiving Cosentyx. Angioedema cases have also been reported in the post-marketing setting. If an anaphylactic or other serious allergic reaction occurs, administration of Cosentyx should be discontinued immediately and appropriate therapy initiated.

Eczematous eruptions

In post-marketing reports, cases of severe eczematous eruptions, including dermatitis-like eruptions, dyshidrotic eczema, and erythroderma (exfoliative dermatitis), were reported in patients receiving Cosentyx; some cases resulted in hospitalization (see section ADVERSE DRUG REACTIONS). The onset of eczematous eruptions was variable, ranging from days to months after the first dose of Cosentyx.

Treatment with Cosentyx may need to be discontinued to resolve the eczematous eruption. Some patients were successfully treated for eczematous eruptions while continuing Cosentyx.

Latex-sensitive individuals – 1 mL pre-filled-syringe/pen and 0.5 mL pre-filled syringe

The removable caps of the Cosentyx 1 mL pre-filled syringe/pen, and 0.5 mL pre-filled syringe, contain a derivative of natural rubber latex. Although no natural rubber latex is detected in the cap, the safe use of Cosentyx pre-filled syringe/pen in latex-sensitive individuals has not been studied.

Vaccinations

Live vaccines should not be given concurrently with Cosentyx (see section INTERACTIONS).

Patients receiving Cosentyx may receive concurrent inactivated or non-live vaccinations.

In a study, after *meningococcal* (polysaccharide) and inactivated *influenza* vaccinations, a similar proportion of healthy subjects treated with a single dose of Cosentyx 150 mg and healthy subjects in the control group (no Cosentyx treatment) were able to mount an adequate immune response of at least a 4-fold increase in antibody titers to *meningococcal* and *influenza* vaccines. The data suggest that Cosentyx does not suppress the humoral immune response to the *meningococcal* or *influenza* vaccines.

Prior to initiating therapy with Cosentyx, it is recommended that pediatric patients receive all age-appropriate immunizations as per current immunization guidelines.

ADVERSE DRUG REACTIONS

Summary of the safety profile

Over 20,000 patients have been treated with Cosentyx in blinded and open-label clinical studies in various indications (plaque psoriasis and other autoimmune conditions), representing 34,908 patient years of exposure.

Of these, over 14,000 patients were exposed to Cosentyx for at least one year.

Adverse reactions in plaque psoriasis

Adult patients

Four placebo-controlled phase III studies in plaque psoriasis were pooled to evaluate the safety of Cosentyx in comparison to placebo up to 12 weeks after treatment initiation. In total, 2,076 patients were evaluated (692 patients on 150 mg, 690 patients on 300 mg and 694 patients on placebo).

The most frequently reported adverse drug reactions (ADRs) were upper respiratory tract infections (most frequently nasopharyngitis, rhinitis). Most of the events were mild or moderate in severity.

In the placebo-controlled period of plaque psoriasis phase III studies the proportion of patients who discontinued treatment due to adverse events was approximately 1.2% in the Cosentyx arm and 1.2% in the placebo arm.

ADRs from psoriasis clinical studies (Table 2) are listed by MedDRA system organ class. Within each system organ class, the ADRs are ranked by frequency, with the most frequent reactions first. Within each frequency grouping, adverse drug reactions are presented in order of decreasing seriousness. In addition, the corresponding frequency category for each adverse drug reaction is based on the following convention (CIOMS III): very common ($\geq 1/10$); common ($\geq 1/100$ to $< 1/10$); uncommon ($\geq 1/1,000$ to $< 1/100$); rare ($\geq 1/10,000$ to $< 1/1,000$); very rare ($< 1/10,000$).

Table 2 Percentage of patients with adverse drug reactions in psoriasis clinical studies¹

Adverse drug reactions	Secukinumab		Placebo (N=694) n (%)	Frequency category ²
	300 mg (N=690) n (%)	150 mg (N=692) n (%)		
Infections and infestations				
Upper respiratory tract infections	117 (17.0)	129 (18.6)	72 (10.4)	Very common
• Nasopharyngitis	79 (11.4)	85 (12.3)	60 (8.6)	Very common
• Upper respiratory tract infection	17 (2.5)	22 (3.2)	5 (0.7)	Common
• Rhinitis	10 (1.4)	10 (1.4)	5 (0.7)	Common
• Pharyngitis	8 (1.2)	7 (1.0)	0 (0)	Common
• Sinusitis	3 (0.4)	6 (0.9)	1(0.1)	Uncommon
• Tonsillitis	4 (0.6)	4 (0.6)	3(0.4)	Uncommon
Oral herpes	9 (1.3)	1 (0.1)	2 (0.3)	Common
Oral candidiasis	4 (0.6)	1 (0.1)	1 (0.1)	Uncommon
Tinea pedis	5 (0.7)	5 (0.7)	0 (0)	Uncommon
Blood and lymphatic system disorders				
Neutropenia	2 (0.3)	1 (0.1)	0 (0)	Uncommon
Eye disorders				

Adverse drug reactions	Secukinumab		Placebo (N=694) n (%)	Frequency category ²
	300 mg (N=690) n (%)	150 mg (N=692) n (%)		
Conjunctivitis	5 (0.7)	2 (0.3)	1 (0.1)	Uncommon
Respiratory, thoracic and mediastinal disorders				
Rhinorrhoea	8 (1.2)	2 (0.3)	1 (0.1)	Common
Gastrointestinal disorders				
Diarrhoea	28 (4.1)	18 (2.6)	10 (1.4)	Common
Inflammatory bowel disease (including Crohn's disease and ulcerative colitis) ³	1 (0.1)	1 (0.1)	0 (0)	Uncommon
Skin and subcutaneous tissue disorders				
Urticaria	4 (0.6)	8 (1.2)	1 (0.1)	Common
Dermatitis (including eczema) 3,4	8 (1.2)	12 (1.7)	3 (0.5)	Common
Dyshidrotic eczema ³	1 (0.1)	1 (0.1)	0 (0)	Uncommon
<p>1) placebo-controlled clinical studies (phase III) in plaque psoriasis patients exposed to 300 mg, 150 mg or placebo up to 12-weeks treatment duration</p> <p>2) ADR frequencies are based upon the highest percentage rate seen in any of the secukinumab groups</p> <p>3) ADR added based on post-marketing reports. Frequency determined based on placebo-controlled clinical studies (phase III) in plaque psoriasis patients</p> <p>4) These events are related to Eczematous eruptions.</p>				

Pediatric patients

The safety of Cosentyx was assessed in two phase III studies in pediatric patients with plaque psoriasis. The first was a double-blind, placebo-controlled study of 162 patients from 6 to less than 18 years of age with severe plaque psoriasis. The second is an open-label study of 84 patients from 6 to less than 18 years of age with moderate to severe plaque psoriasis. The safety profile reported in these studies was consistent with the safety profile reported in adult plaque psoriasis patients.

The safety of Cosentyx was also assessed in a Phase III study in 86 pediatric patients from 2 to less than 18 years of age with the ERA and JPsA categories of JIA. The safety profile reported in this study was consistent with the safety profile reported in adult patients.

Adverse drug reactions from spontaneous reports and literature cases (frequency not known)

The following adverse drug reactions have been derived from post-marketing experience with Cosentyx via spontaneous case reports and literature cases. Because these reactions are

reported voluntarily from a population of uncertain size, it is not possible to reliably estimate their frequency which is therefore categorized as not known. Adverse drug reactions are listed according to system organ classes in MedDRA. Within each system organ class, ADRs are presented in order of decreasing seriousness.

Table 3 Adverse drug reactions from spontaneous reports and literature (frequency not known)

Infections and infestations
Mucosal and cutaneous candidiasis

Skin and subcutaneous tissue disorders
Pyoderma gangrenosum
Dermatitis exfoliative generalized
Angioedema

Description of selected adverse drug reactions

Adult patients

Infections

In the placebo-controlled period of clinical studies in plaque psoriasis (a total of 1,382 patients treated with Cosentyx and 694 patients treated with placebo for up to 12 weeks), infections were reported in 28.7% of patients treated with Cosentyx compared with 18.9% of patients treated with placebo. Most of these were mild or moderate. Serious infections occurred in 0.14% of patients treated with Cosentyx and in 0.3% of patients treated with placebo (see section WARNINGS AND PRECAUTIONS).

Over the entire treatment period (a total of 3,430 patients treated with Cosentyx for up to 52 weeks for the majority of patients), infections were reported in 47.5% of patients treated with Cosentyx (0.9 per patient-year of follow-up). Serious infections were reported in 1.2% of patients treated with Cosentyx (0.015 per patient-year of follow-up).

Infection rates as observed in psoriatic arthritis and axial spondyloarthritis (ankylosing spondylitis and non-radiographic axial spondyloarthritis) clinical studies were similar to what was observed in the psoriasis studies.

Due to the nature of the lesions, patients with hidradenitis suppurativa are more susceptible to infections. In the placebo-controlled period of clinical studies in hidradenitis suppurativa (a total of 721 patients treated with secukinumab and 363 patients treated with placebo for up to 16 weeks), infections were numerically higher to those observed in the psoriasis studies (30.7% of patients treated with secukinumab compared with 31.7% in patients treated with placebo). Most of these were non-serious, mild or moderate in severity and did not require treatment discontinuation or interruption.

Hypersensitivity reactions

In clinical studies, urticaria, rare cases of anaphylactic reactions and angioedema have been observed in patients receiving Cosentyx. Angioedema cases have also been reported in the post-marketing setting.

Immunogenicity

In psoriasis, psoriatic arthritis, axial spondyloarthritis (ankylosing spondylitis and non-radiographic axial spondyloarthritis), and hidradenitis suppurativa clinical studies, less than 1% of patients treated with Cosentyx developed antibodies to secukinumab up to 52 weeks of treatment. About half of the treatment emergent anti-drug antibodies were neutralizing, but this was not associated with loss of efficacy or PK abnormalities.

Adverse reactions in psoriatic arthritis

Cosentyx was studied in five placebo-controlled psoriatic arthritis trials with 2,754 patients (1,871 patients on Cosentyx and 883 patients on placebo) with a total exposure of 4,478 patient years of study exposure on Cosentyx. The safety profile observed in patients with psoriatic arthritis treated with Cosentyx is consistent with the safety profile in psoriasis.

Adverse reactions in axial spondyloarthritis (ankylosing spondylitis and non-radiographic axial spondyloarthritis)

Cosentyx was studied in three placebo-controlled ankylosing spondylitis trials with 816 patients (544 patients on Cosentyx and 272 patients on placebo). The median duration of exposure for secukinumab-treated patients was 469 days in AS 1 Study, 460 days in AS 2 Study, and 1,142 days in AS 3 Study. Cosentyx was also studied in one placebo-controlled non-radiographic axial spondyloarthritis trial with 555 patients (369 patients on Cosentyx and 186 patients on placebo) for a total of 588 patient-years of study exposure (median duration of exposure for secukinumab-treated patients: 395 days). The safety profile observed in patients with axial spondyloarthritis (ankylosing spondylitis and non-radiographic axial spondyloarthritis) treated with Cosentyx is consistent with the safety profile in psoriasis.

Adverse reactions in hidradenitis suppurativa

Cosentyx was studied in two placebo-controlled hidradenitis suppurativa trials with 1,084 patients (721 patients on Cosentyx and 363 on placebo) with a total exposure of 825 patient years of study exposure (median duration of exposure for secukinumab-treated patients: 307 days). The safety profile observed in patients with HS treated with Cosentyx was consistent with the known safety profile observed in psoriasis.

INTERACTIONS

Live vaccines should not be given concurrently with Cosentyx (see section WARNINGS AND PRECAUTIONS).

In a study in adult subjects with plaque psoriasis, no interaction was observed between secukinumab and midazolam (CYP 3A4 substrate).

Cosentyx has been concomitantly administered with methotrexate (MTX) and/or corticosteroids in arthritis studies (including psoriatic arthritis and axial spondyloarthritis) where no interaction was seen.

PREGNANCY, LACTATION, FEMALES AND MALES OF REPRODUCTIVE POTENTIAL

Pregnancy

Risk Summary

There are no adequate data from the use of Cosentyx in pregnant women. Animal studies do not indicate direct or indirect harmful effects with respect to pregnancy, embryonic/fetal development, parturition or postnatal development. Because animal reproduction studies are not always predictive of human response, Cosentyx should be used during pregnancy only if the benefits clearly outweigh the potential risks.

Animal Data

In an embryofetal development study in cynomolgus monkeys, secukinumab showed no maternal toxicity, embryotoxicity or teratogenicity when administered throughout organogenesis and late gestation.

No undesirable effects of an anti-murine IL-17A antibody were seen in a pre-and postnatal development study in mice. The high dose used in this study was in excess of the maximally effective dose in terms of IL-17A suppression and activity.

Lactation

It is not known whether secukinumab is excreted in human milk. Because immunoglobulins are excreted in human milk, caution should be exercised when Cosentyx is administered to a woman who is breast-feeding.

Females and males of reproductive potential

Infertility

There are no special recommendations for females of reproductive potential.

The effect of Cosentyx on human fertility has not been evaluated. No undesirable effects of an anti-murine IL-17A antibody were seen in fertility and early embryonic development studies in mice. The high dose used in the study was in excess of the maximally effective dose in terms of IL-17A suppression and activity.

OVERDOSAGE

No cases of overdose have been reported in clinical studies.

Doses up to 30 mg/kg (i.e., approximately 2,000 to 3,000 mg) have been administered intravenously in clinical studies without dose-limiting toxicity. In the event of overdose, it is recommended that the patient be monitored for any signs or symptoms of adverse reactions and appropriate symptomatic treatment be instituted immediately.

CLINICAL PHARMACOLOGY

Pharmacotherapeutic group, ATC

Interleukin inhibitors; ATC code L04AC10.

Mechanism of action (MOA)

Secukinumab is a fully human IgG1 antibody that selectively binds to and neutralizes the proinflammatory cytokine interleukin-17A (IL-17A). Secukinumab works by targeting IL-17A and inhibiting its interaction with the IL-17 receptor, which is expressed on various cell types including keratinocytes and synoviocytes. As a result, secukinumab inhibits the release of proinflammatory cytokines, chemokines and mediators of tissue damage and reduces IL-17A-mediated contributions to autoimmune and inflammatory diseases. Clinically relevant levels of secukinumab reach the skin and reduce local inflammatory markers. As a direct consequence treatment with secukinumab reduces erythema, induration, and desquamation present in plaque psoriasis lesions.

IL-17A is a naturally occurring cytokine that is involved in normal inflammatory and immune responses. IL-17A plays a key role in the pathogenesis of plaque psoriasis, hidradenitis suppurativa, psoriatic arthritis and axial spondyloarthritis (ankylosing spondylitis and non-radiographic axial spondyloarthritis). Increased numbers of IL-17A producing lymphocytes and innate immune cells and increased levels of IL-17A have been found in the blood of

patients with plaque psoriasis, psoriatic arthritis, axial spondyloarthritis and affected skin of patients with plaque psoriasis. IL-17A is highly up-regulated in lesional skin in contrast to non-lesional skin of plaque psoriasis patients. Furthermore higher frequency of IL-17-producing cells was detected in the synovial fluid of patients with psoriatic arthritis. IL-17A is considerably upregulated in hidradenitis suppurativa lesions compared to psoriasis patients and healthy controls, and significantly increased IL-17A serum levels have been observed in affected patients. The frequency of IL-17 producing cells was also significantly higher in the subchondral bone marrow of facet joints from patients with axial spondyloarthritis. Inhibition of IL-17A was shown to be effective in the treatment of AS, thus establishing the key role of this cytokine in axial spondyloarthritis (see section Clinical studies)

IL-17A also promotes tissue inflammation, neutrophil infiltration, bone and tissue destruction, and tissue remodeling including angiogenesis and fibrosis.

Pharmacodynamics (PD)

Serum levels of total IL-17A (free and secukinumab-bound IL-17A) are increased due to reduced clearance of secukinumab-bound IL-17A within 2 to 7 days in patients receiving secukinumab, indicating that secukinumab selectively captures free IL-17A which plays a key role in the pathogenesis of plaque psoriasis.

In a study with secukinumab, infiltrating epidermal neutrophils and various neutrophil associated markers that are increased in lesional skin of plaque psoriasis patients were significantly reduced after one to two weeks of treatment.

Secukinumab has been shown to lower (within 1 to 2 weeks of treatment) levels of C-reactive protein, which is a marker of inflammation in psoriatic arthritis and axial spondyloarthritis (ankylosing spondylitis and non-radiographic axial spondyloarthritis).

Pharmacokinetics (PK)

Absorption

Following a single subcutaneous dose of either 150 mg, or 300 mg administered as two injections of 150 mg in plaque psoriasis patients, secukinumab reached peak serum concentrations of 13.7 ± 4.8 microgram/mL or 27.3 ± 9.5 microgram/mL, respectively, between 5 and 6 days post dose.

After the initial weekly dosing during the first month, the time to reach the maximum concentration was between 31 and 34 days.

Peak concentrations at steady-state ($C_{\max,ss}$) following subcutaneous administration of 150 mg or 300 mg were 27.6 microgram/mL and 55.2 microgram/mL, respectively. Steady-state is reached after 20 weeks with monthly dosing regimens.

Compared with exposure after a single dose, patients exhibited a 2-fold increase in peak serum concentrations and AUC following repeated monthly dosing during maintenance.

Secukinumab is absorbed with an average absolute bioavailability of 73%.

Following multiple subcutaneous doses of 300 mg administered via the 300 mg/2 mL pen in plaque psoriasis patients, the mean serum trough concentrations of secukinumab were consistent with those observed in the previous 150 mg/1 mL studies used to deliver 300 mg.

Following subcutaneous administrations of 300 mg at Weeks 0, 1, 2, 3, and 4 followed by 300 mg every 2 weeks, the mean \pm SD steady-state secukinumab trough concentration at Week 16 was approximately 55.1 ± 26.7 $\mu\text{g/ml}$ and 58.1 ± 30.1 $\mu\text{g/ml}$ in HS study 1 and HS study 2, respectively.

Distribution

The mean volume of distribution during the terminal phase (V_z) following a single intravenous administration ranged from 7.10 to 8.60 L in plaque psoriasis patients suggesting that secukinumab undergoes limited distribution to peripheral compartments.

Secukinumab concentrations in interstitial fluid in the skin of plaque psoriasis patients ranged from 28% to 39% of those in serum at 1 and 2 weeks after a single subcutaneous dose of 300 mg secukinumab (administered as two injections of 150 mg).

Elimination

Mean systemic clearance (CL) was 0.19 L/d in plaque psoriasis patients. Clearance was dose- and time-independent, as expected for a therapeutic IgG1 monoclonal antibody interacting with a soluble cytokine target, such as IL-17A.

The mean elimination half-life was estimated to be 27 days in plaque psoriasis patients.

Estimated half-lives in individual plaque psoriasis patients range from 17 to 41 days.

In a population pharmacokinetic analysis, the mean systemic CL following subcutaneous administrations of 300 mg at Weeks 0, 1, 2, 3, and 4 followed by 300 mg every 2 weeks to patients with hidradenitis suppurativa was 0.26 l/day.

The mean elimination half-life, as estimated from population pharmacokinetic analysis, was

23 days in hidradenitis suppurativa patients.

Weight

Secukinumab clearance and volume of distribution increase as body weight increases.

Dose linearity

The single and multiple dose pharmacokinetics of secukinumab in plaque psoriasis patients were determined in several studies with intravenous doses ranging from 1 x 0.3 mg/kg to 3 x 10 mg/kg and with subcutaneous doses ranging from 1 x 25 mg to multiple doses of 300 mg. Exposure was dose proportional across all dosing regimens.

The PK properties of secukinumab observed in psoriatic arthritis and axial spondyloarthritis (ankylosing spondylitis and non-radiographic axial spondyloarthritis) patients were similar to those displayed in plaque psoriasis patients.

Special populations

Elderly patients

Of the 3,430 plaque psoriasis patients exposed to Cosentyx in clinical studies, a total of 230 were 65 years of age or older and 32 patients were 75 years of age or older.

Of the 2,536 psoriatic arthritis patients exposed to Cosentyx in clinical studies, a total of 236 patients were 65 years of age or older and 25 patients were 75 years of age or older.

Of the 794 ankylosing spondylitis patients exposed to Cosentyx in clinical studies, a total of 29 patients were 65 years of age or older and 3 patients were 75 years of age or older.

Of the 524 non-radiographic axial spondyloarthritis patients exposed to Cosentyx in clinical studies, a total of 9 patients were 65 years of age or older and 2 patients were 75 years of age or older.

Of the 721 hidradenitis suppurativa patients exposed to Cosentyx in clinical studies, a total of 11 patients were 65 years of age or older and 0 patients were 75 years of age or older.

Based on population PK analysis, clearance in elderly patients and patients less than 65 years of age was similar.

Patients with renal and hepatic impairment

No pharmacokinetic data are available in patients with hepatic or renal impairment.

Pediatric patients

Plaque psoriasis

In a pool of the two pediatric studies, patients with moderate to severe plaque psoriasis (6 to less than 18 years of age) were administered secukinumab at the recommended pediatric dosing regimen. At Week 24, patients weighing ≥ 25 and < 50 kg had a mean \pm SD steady-state trough concentration of 19.8 ± 6.96 microgram/mL (n=24) after 75 mg of secukinumab, and patients weighing ≥ 50 kg had a mean \pm SD steady-state trough concentration of 27.3 ± 10.1 microgram/mL (n=36) after 150 mg of secukinumab. The mean \pm SD steady-state trough concentration in patients weighing < 25 kg (n=8) was 32.6 ± 10.8 microgram/mL at Week 24 after 75 mg dose.

Juvenile Idiopathic Arthritis (JIA): Enthesitis-Related Arthritis (ERA) and Juvenile Psoriatic Arthritis (JPsA)

In a pediatric study, ERA and JPsA patients (2 to less than 18 years of age) were administered secukinumab at the recommended pediatric dosing regimen. At Week 24, patients weighing < 50 kg, and patients weighing ≥ 50 kg had a mean \pm SD steady-state trough concentration of 25.2 ± 5.45 microgram/mL (n = 10) and 27.9 ± 9.57 microgram/mL (n = 19), respectively.

CLINICAL STUDIES

Psoriasis

Adult patients

The safety and efficacy of Cosentyx were assessed in four randomized, double-blind, placebo-controlled phase 3 studies in patients with moderate to severe plaque psoriasis who were candidates for phototherapy or systemic therapy [ERASURE, FIXTURE, FEATURE, JUNCTURE]. The efficacy and safety of Cosentyx 150 mg and 300 mg were evaluated versus either placebo or etanercept. In addition, one study assessed a chronic treatment regimen versus a 'retreatment as needed' regimen [SCULPTURE]. In these studies, each 300 mg dose was given as two subcutaneous injections of 150 mg.

Of the 2,403 patients who were included in the placebo-controlled studies, 37% were systemic naïve, 79% were biologic-naïve, 48% were systemic failures, 45% were non- biologic failures, 8% were biologic failures, 6% were anti-TNF failures, and 2% were anti-p40 failures. Baseline disease characteristics were generally consistent across all treatment groups with a median baseline Psoriasis Area Severity Index (PASI) score from 19 to 20, IGA mod 2011

baseline score ranged from “moderate” (62%) to “severe” (38%), median baseline Body Surface Area (BSA) ≥ 27 and median Dermatology Life Quality Index (DLQI) score from 10 to 12. Approximately 15 to 25% of patients in phase III studies had psoriatic arthritis (PsA) at baseline.

Psoriasis Study 1 (ERASURE) evaluated 738 patients. Patients randomized to Cosentyx received 150 mg or 300 mg doses at Weeks 0, 1, 2, 3, and 4 followed by the same dose every month. Patients randomized to receive placebo who were non-responders at Week 12 were then crossed over to receive Cosentyx (either 150 mg or 300 mg) at Weeks 12, 13, 14, and 15, followed by the same dose every month starting at Week 16. All patients were followed for up to 52 weeks following first administration of study treatment.

Psoriasis Study 2 (FIXTURE) evaluated 1,306 patients. Patients randomized to Cosentyx received 150 mg or 300 mg doses at Weeks 0, 1, 2, 3, and 4 followed by the same dose every month. Patients randomized to etanercept received 50 mg doses twice per week for 12 weeks followed by 50 mg every week. Patients randomized to receive placebo who were non-responders at Week 12 then crossed over to receive Cosentyx (either 150 mg or 300 mg) at Weeks 12, 13, 14, and 15, followed by the same dose every month starting at Week 16. All patients were followed for up to 52 weeks following first administration of study treatment.

Psoriasis Study 3 (FEATURE) evaluated 177 patients using a pre-filled syringe compared with placebo after 12 weeks of treatment to assess the safety, tolerability, and usability of Cosentyx self-administration via the pre-filled syringe. Patients randomized to Cosentyx received 150 mg or 300 mg doses at Weeks 0, 1, 2, 3, and 4 followed by the same dose every month. Patients were also randomized to receive placebo at Weeks 0, 1, 2, 3, and 4 followed by the same dose every month.

Psoriasis Study 4 (JUNCTURE) evaluated 182 patients using a pre-filled pen compared with placebo after 12 weeks of treatment to assess the safety, tolerability, and usability of Cosentyx self-administration via the pre-filled pen. Patients randomized to Cosentyx received 150 mg or 300 mg doses at Weeks 0, 1, 2, 3, and 4 followed by the same dose every month. Patients were also randomized to receive placebo at Weeks 0, 1, 2, 3, and 4 followed by the same dose every month.

Psoriasis Study 5 (SCULPTURE) evaluated 966 patients. All patients received Cosentyx 150 mg or 300 mg doses at Weeks 0, 1, 2, 3, 4, 8 and 12 and then were randomized to receive either a maintenance regimen of the same dose every month starting at Week 12 or a “retreatment as needed” regimen of the same dose. Patients randomized to “retreatment as

needed” did not achieve adequate maintenance of response and therefore a fixed monthly maintenance regimen is recommended.

The co-primary endpoints in the placebo and active controlled studies were the proportion of patients who achieved a PASI 75 response and IGA mod 2011 ‘clear’ or ‘almost clear’ response versus placebo at Week 12 (see Tables 4 and 5). The 300 mg dose provided improved skin clearance across efficacy endpoints of PASI 75/90/100, and IGA mod 2011 ‘clear’ or ‘almost clear’ responses across all studies with peak effects seen at Week 16, therefore this dose is recommended.

Table 4 Summary of PASI 50/75/90/100 & IGA* mod 2011 ‘clear’ or ‘almost clear’ clinical response in Psoriasis Studies 1, 3 and 4 (ERASURE, FEATURE and JUNCTURE)

	Week 12			Week 16		Week 52	
	Placebo	150 mg	300 mg	150 mg	300 mg	150 mg	300 mg
Study 1							
Number of patients	246	244	245	244	245	244	245
PASI 50 response n (%)	22 (8.9%)	203 (83.5%)	222 (90.6%)	212 (87.2%)	224 (91.4%)	187 (77%)	207 (84.5%)
PASI 75 response n (%)	11 (4.5%)	174 (71.6%)**	200 (81.6%)**	188 (77.4%)	211 (86.1%)	146 (60.1%)	182 (74.3%)
PASI 90 response n (%)	3 (1.2%)	95 (39.1%)**	145 (59.2%)**	130 (53.5%)	171 (69.8%)	88 (36.2%)	147 (60.0%)
PASI 100 response n (%)	2 (0.8%)	31 (12.8%)	70 (28.6%)	51 (21.0%)	102 (41.6%)	49 (20.2%)	96 (39.2%)
IGA mod 2011 “clear” or “almost clear” response n (%)	6 (2.40%)	125 (51.2%)**	160 (65.3%)**	142 (58.2%)	180 (73.5%)	101 (41.4%)	148 (60.4%)
Study 3							
Number of patients	59	59	58	-	-	-	-
PASI 50 response n (%)	3 (5.1%)	51 (86.4%)	51 (87.9%)	-	-	-	-
PASI 75 response n (%)	0 (0.0%)	41 (69.5%)**	44 (75.9%)**	-	-	-	-
PASI 90 response n (%)	0 (0.0%)	27 (45.8%)	35 (60.3%)	-	-	-	-
PASI 100 response n (%)	0 (0.0%)	5 (8.5%)	25 (43.1%)	-	-	-	-
IGA mod 2011 “clear” or “almost clear” response n (%)	0 (0.0%)	31 (52.5%)**	40 (69.0%)**	-	-	-	-
Study 4							
Number of patients	61	60	60	-	-	-	-
PASI 50 response n (%)	5 (8.2%)	48 (80.0%)	58 (96.7%)	-	-	-	-
PASI 75 response n (%)	2 (3.3%)	43 (71.7%)**	52 (86.7%)**	-	-	-	-
PASI 90 response n (%)	0 (0.0%)	24 (40.0%)	33 (55.0%)	-	-	-	-
PASI 100 response n (%)	0 (0.0%)	10 (16.7%)	16 (26.7%)	-	-	-	-

	Week 12			Week 16		Week 52	
	Placebo	150 mg	300 mg	150 mg	300 mg	150 mg	300 mg
IGA mod 2011 “clear” or “almost clear” response n (%)	0 (0.0%)	32 (53.3%)**	44 (73.3%)**	-	-	-	-

**The IGA mod 2011 is a 5-category scale including “0 = clear”, “1 = almost clear”, “2 = mild”, “3 = moderate” or “4 = severe”, indicating the physician’s overall assessment of the psoriasis severity focusing on induration, erythema and scaling. Treatment success of “clear” or “almost clear” consisted of no signs of psoriasis or normal to pink coloration of lesions, no thickening of the plaque and none to minimal focal scaling.*

*** p values versus placebo and adjusted for multiplicity: p<0.0001*

Table 5 Summary of clinical response on Psoriasis Study 2 (FIXTURE)

	Week 12				Week 16			Week 52		
	Placebo	150 mg	300 mg	Etanercept	150 mg	300 mg	Etanercept	150 mg	300 mg	Etanercept
Number of patients	324	327	323	323	327	323	323	327	323	323
PASI 50 response n (%)	49 (15.1%)	266 (81.3%)	296 (91.6%)	226 (70.0%)	290 (88.7%)	302 (93.5%)	257 (79.6%)	249 (76.1%)	274 (84.8%)	234 (72.4%)
PASI 75 response n (%)	16 (4.9%)	219 (67.0%) **	249 (77.1%) **	142 (44.0%)	247 (75.5%)	280 (86.7%)	189 (58.5%)	215 (65.7%)	254 (78.6%)	179 (55.4%)
PASI 90 response n (%)	5 (1.5%)	137 (41.9%)	175 (54.2%)	67 (20.7%)	176 (53.8%)	234 (72.4%)	101 (31.3%)	147 (45.0%)	210 (65.0%)	108 (33.4%)
PASI 100 response n (%)	0 (0%)	47 (14.4%)	78 (24.1%)	14 (4.3%)	84 (25.7%)	119 (36.8%)	24 (7.4%)	65 (19.9%)	117 (36.2%)	32 (9.9%)
IGA mod 2011 “clear” or “almost clear” response n (%)	9 (2.8%)	167 (51.1%) **	202 (62.5%) **	88 (27.2%)	200 (61.2%)	244 (75.5%)	127 (39.3%)	168 (51.4%)	219 (67.8%)	120 (37.2%)

*** p values versus etanercept: p=0.0250*

An additional psoriasis study (CLEAR) evaluated 676 patients. Secukinumab 300 mg met the primary and secondary endpoints by showing superiority to ustekinumab based on PASI 90 response at Week 16 (primary endpoint), speed of onset of PASI 75 response at Week 4, and long-term PASI 90 response at Week 52. Greater efficacy of secukinumab compared to ustekinumab for the endpoints PASI 75/90/100 and IGA mod 2011 0 or 1 response (“clear” or “almost clear”) was observed early and continued through Week 52. In this study, each 300 mg dose was given as two injections of 150 mg.

Table 6 Summary of clinical response on CLEAR Study

	Week 4		Week 16		Week 52	
	Secukinumab 300 mg	Ustekinumab*	Secukinumab 300 mg	Ustekinumab*	Secukinumab 300 mg	Ustekinumab*
Number of patients	334	335	334	335	334	335
PASI 75 response n (%)	166 (49.7%)**	69 (20.6%)	311 (93.1%)	276 (82.4%)	306 (91.6%)	262 (78.2%)
PASI 90 response n (%)	70 (21.0%)	18 (5.4%)	264 (79.0%)**	192 (57.3%)	250 (74.9%)***	203 (60.6%)
PASI 100 response n (%)	14 (4.2%)	3 (0.9%)	148 (44.3%)	95 (28.4%)	150 (44.9%)	123 (36.7%)
IGA mod 2011 "clear" or "almost clear" response n (%)	128 (38.3%)	41 (12.2%)	278 (83.2%)	226 (67.5%)	261 (78.1%)	213 (63.6%)

*Patients treated with secukinumab received 300 mg doses at Weeks 0, 1, 2, 3 and 4, followed by the same dose every 4 weeks until Week 52. Patients treated with ustekinumab received 45 mg or 90 mg at Weeks 0 and 4, then every 12 weeks until Week 52 (dosed by weight as per approved posology)

** p values versus ustekinumab: $p < 0.0001$ for primary endpoint of PASI 90 at Week 16 and secondary endpoint of PASI 75 at Week 4

*** p value versus ustekinumab: $p = 0.0001$ for secondary endpoint of PASI 90 at Week 52

Cosentyx was efficacious in biologic-naïve, biologic/anti-TNF-exposed and biologic/anti-TNF-failure patients.

Cosentyx was associated with a fast onset of efficacy as shown in the figure below with a 50% reduction in mean PASI by Week 3 for 300 mg.

Figure 1 Time course of percentage change from baseline of mean PASI score in Study 1 (ERASURE)

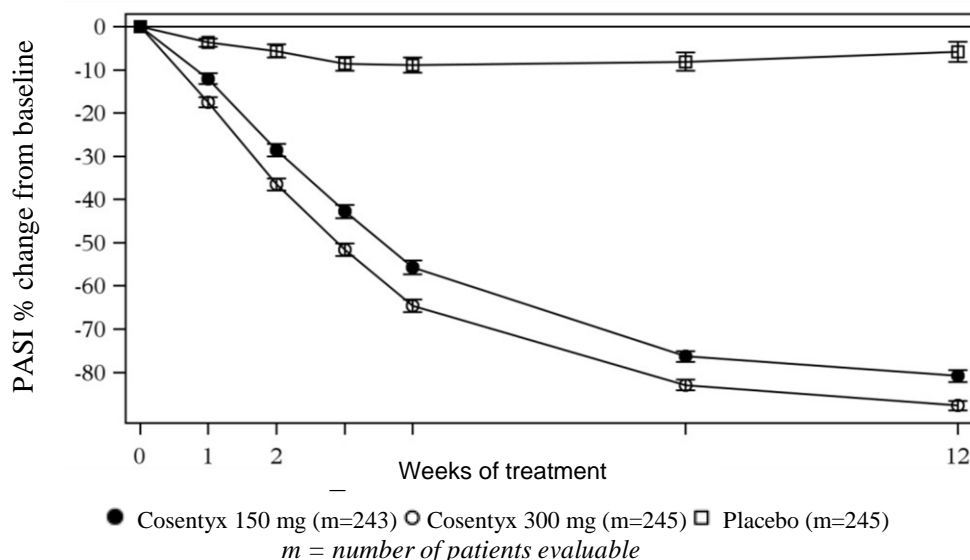

All plaque psoriasis phase III studies included approximately 15 to 25% of patients with concurrent psoriatic arthritis at baseline. Improvements in PASI 75 in this patient population were similar to those in the overall plaque psoriasis population.

In the placebo-controlled studies 1 and 2 in the subset of psoriatic arthritis patients, physical function was assessed using the HAQ Disability Index (HAQ-DI). In these studies, patients treated with 150 mg or 300 mg Cosentyx showed greater improvement from baseline in

the HAQ-DI score (mean decreases of -27.5% and -50.2% at Week 12) compared to placebo (-8.9%). This improvement was maintained up to Week 52.

Specific locations/forms of plaque psoriasis

In two additional placebo-controlled studies, improvement was seen in both nail psoriasis (TRANSFIGURE, 198 patients) and palmoplantar plaque psoriasis (GESTURE, 205 patients). In the TRANSFIGURE study, secukinumab was superior to placebo at Week 16 (46.1% for 300 mg, 38.4% for 150 mg and 11.7% for placebo) as assessed by significant improvement from baseline in the Nail Psoriasis Severity Index (NAPSI %) for patients with moderate to severe plaque psoriasis with nail involvement. In the GESTURE study, secukinumab was superior to placebo at Week 16 (33.3% for 300 mg, 22.1% for 150 mg, and 1.5% for placebo) as assessed by significant improvement of ppIGA 0 or 1 response (“clear” or “almost clear”) for patients with moderate to severe palmoplantar psoriasis. In these studies, each 300 mg dose was given as two subcutaneous injections of 150 mg.

The placebo-controlled SCALP study evaluated 102 patients with moderate to severe scalp psoriasis, defined as having a Psoriasis Scalp Severity Index (PSSI) score of ≥ 12 , an IGA mod 2011 scalp only score of 3 or greater, and at least 30% of the scalp affected. In this study, 62% of patients had at least 50% or more of scalp surface area affected. Secukinumab 300 mg was superior to placebo at Week 12 as assessed by significant improvement from baseline in both the PSSI 90 response (52.9% vs. 2.0%) and IGA mod 2011 0 or 1 scalp only response (56.9% vs. 5.9%). Greater efficacy of secukinumab 300 mg over placebo for both endpoints was observed by Week 3. Improvement in both endpoints was sustained for secukinumab patients who continued treatment through Week 24 (PSSI 90 response 58.8% and IGA mod 2011 0 or 1 scalp only response 62.7%). In this study, each 300 mg dose was given as two injections of 150 mg.

Quality of Life / Patient reported outcomes

Statistically significant improvements at Week 12 (Studies 1-4) from baseline compared to placebo were demonstrated in the DLQI (Dermatology Life Quality Index), these improvements were maintained for 52 weeks (Studies 1 and 2).

Statistically significant improvements at Week 12 from baseline compared to placebo (Studies 1 and 2) in patient reported signs and symptoms of itching, pain and scaling were demonstrated in the validated Psoriasis Symptom Diary[©].

Statistically significant improvements at Week 4 from baseline in patients treated with

secukinumab compared to patients treated with ustekinumab (CLEAR) were demonstrated in the DLQI (Dermatology Life Quality Index), and these improvements were maintained for up to 52 weeks. The Work Productivity and Activity Impairment Questionnaire-Psoriasis outcomes (WPAI-PSO) showed greater improvement in patients treated with secukinumab compared to patients treated with ustekinumab.

Statistically significant improvements in patient reported signs and symptoms of itching, pain and scaling at Week 16 and Week 52 (CLEAR) were demonstrated in the Psoriasis Symptom Diary in patients treated with secukinumab compared to patients treated with ustekinumab.

Statistically significant improvements at Week 12 from baseline compared to placebo (SCALP) were demonstrated in the HRQoL (Health Related Quality of Life Index) as measured by Scalpdx. These improvements were observed starting at Week 4 and were maintained through 24 weeks.

Statistically significant improvements (decreases) at Week 12 from baseline (SCALP) were demonstrated in patient reported signs and symptoms of scalp itching (-59.4%), pain (-45.9%), and scaling (-69.5%), whereas placebo treated patients demonstrated worsening (increases) in scalp itching (7.7%) and pain (38.5%), and less improvement in scalp scaling (-4.7%).

300 mg/2 mL pre-filled syringe and 300 mg/2 mL pre-filled pen

Two randomized, double-blind, placebo-controlled studies in patients with plaque psoriasis were conducted to evaluate the safety and efficacy of secukinumab 300 mg when administered subcutaneously as a single 2 mL pre-filled syringe (ALLURE, 214 patients) or as a single 2 mL pre-filled pen (MATURE, 122 patients) compared to secukinumab 300 mg when administered as two subcutaneous injections in a 150 mg/1 mL pre-filled syringe. The co-primary endpoints were the proportion of patients who achieved a PASI 75 response and IGA mod 2011 'clear' or 'almost clear' response versus placebo at Week 12.

In the ALLURE study, the proportion of subjects achieving a PASI 75 and an IGA mod 2011 0 or 1 responses at Week 12 were 88.9% and 76.4% for the secukinumab 300 mg/2mL pre-filled syringe group compared to 1.7% and 1.4% in the placebo group. In the MATURE study, the proportion of subjects achieving a PASI 75 and an IGA mod 2011 0 or 1 responses at Week 12 were 95.1% and 75.6% for the secukinumab 300 mg/2mL pre-filled pen group compared to 10% and 7.6% in the placebo group. PASI 90 response at Week 12 was achieved with secukinumab 300 mg/2mL pre-filled syringe (ALLURE study) and secukinumab 300 mg/2mL pre-filled pen (MATURE study) compared to placebo in 66.7% versus 1.6% of subjects,

respectively (ALLURE study) and 75.6% versus 5% of subjects, respectively (MATURE study).

The overall patient experience with subcutaneous self-injection with the 300 mg/2 mL pre-filled syringe and the 300 mg/2 mL pre-filled pen was measured using the Self-Injection Assessment Questionnaire (SIAQ). In the ALLURE study, the proportion of “very satisfied” and “satisfied” patients reached 89.5% at Week 28. In the MATURE study, the proportion of “very satisfied” and “satisfied” patients reached 91.8% at Week 12.

With continued treatment over 52 weeks, the proportion of PASI 75/90/100 and IGA mod 2011 0 or 1 responders in the ALLURE study increased up to Week 28 and the responses were then maintained through Week 52. At Week 52, the PASI 75/90/100 and IGA mod 2011 0 or 1 response rates for the secukinumab 300 mg/2 mL pre-filled syringe group were 88.2%, 75.6%, 55.2%, and 76.5%, respectively, and 87.2%, 81.7%, 52.5%, and 76.8%, respectively for the secukinumab 2 × 150 mg/1 mL pre-filled syringe group

Plaque Psoriasis Dose Flexibility

The efficacy, safety, and tolerability of Cosentyx 300 mg administered every 4 weeks vs. Cosentyx 300 mg administered every 2 weeks in adult patients weighing ≥ 90 kg with moderate to severe plaque psoriasis were assessed in a randomized, double-blind, multicenter study of 331 patients. Patients were randomized 1:1 as follows:

- secukinumab 300 mg at Weeks 0, 1, 2, 3, and 4 followed by the same dose every 2 weeks up to Week 52 (n=165).
- secukinumab 300 mg at Weeks 0, 1, 2, 3, and 4 followed by the same dose every 4 weeks up to Week 16 (n=166).
 - Patients randomized to receive secukinumab 300 mg every 4 weeks who were PASI 90 responders at Week 16 continued to receive the same dosing regimen up to Week 52. Patients randomized to receive Cosentyx 300 mg every 4 weeks who were PASI 90 non-responders at Week 16 either continued on the same dosing regimen, or were reassigned to receive Cosentyx 300 mg every 2 weeks up to Week 52.

The primary and key secondary endpoints were the proportion of patients who achieved a PASI 90 response and IGA mod 2011 ‘clear’ or ‘almost clear’ (0 or 1) response at Week 16. At Week 16, the proportion of patients who were PASI 90 responders was higher in the group treated with the every 2 week regimen vs. the every 4 week regimen (73.2% vs. 55.5%, respectively). The treatment difference was clinically relevant and statistically significant (one-

sided p-value = 0.0003). The proportion of patients who achieved an IGA mod 2011 ‘clear’ or ‘almost clear’ response was also higher in the group treated with the every 2 week regimen vs. the group treated with the every 4 week regimen (74.2% vs. 65.9%, respectively).

At Week 52, the proportion of patients that were PASI 75, PASI 90, PASI 100, and IGA 0/1 responders was higher in patients treated with the every 2 week regimen vs. patients treated with the every 4 week regimen (88.9% vs. 74.8%, 76.4% vs. 52.4%, 46.7% vs. 27.3%, 75.9% vs. 55.6%, respectively). For all endpoints, the treatment difference was statistically significant (p-value < 0.05). The DLQI 0/1 response at Week 52 was superior in the group treated with the every 2 week regimen vs. the group treated with the every 4 week regimen (66.1% vs. 48.8%).

The PASI 90 non-responders at Week 16 reassigned to receive the every 2 week regimen had a higher PASI 90 response at Week 32 than the group who continued on the treatment regimen of every 4 weeks (38.7% vs. 16.5%). The treatment difference was statistically significant (two-sided p-value = 0.0439).

Similarly, the PASI 75 response at Week 32 in the patients reassigned to receive the every 2 week regimen was significantly higher (two-sided p-value = 0.0015) than for the group who continued on the treatment regimen of every 4 weeks (90.3% vs. 49.3%). The IGA 0/1 response at Week 32 was also higher in the patient group receiving the every 2 week regimen (41.9% vs. 29.0%) as was the DLQI 0/1 response at Week 32 (41.9% vs. 30.0%).

Patients on the every 2 week regimen vs. the every 4 week regimen (Figure 2) showed consistent overall benefit, and benefit for all the subgroups (weight, IGA, and time since diagnosis). The highest incremental benefit as shown by the calculated risk differences was for patients with severe disease (IGA 4), very long duration disease (>25 years) and greater weight.

Figure 2 Forest plot of risk difference of PASI 90 response at Week 16 with subgroups (modified non-responders' imputation) – Full Analysis set*

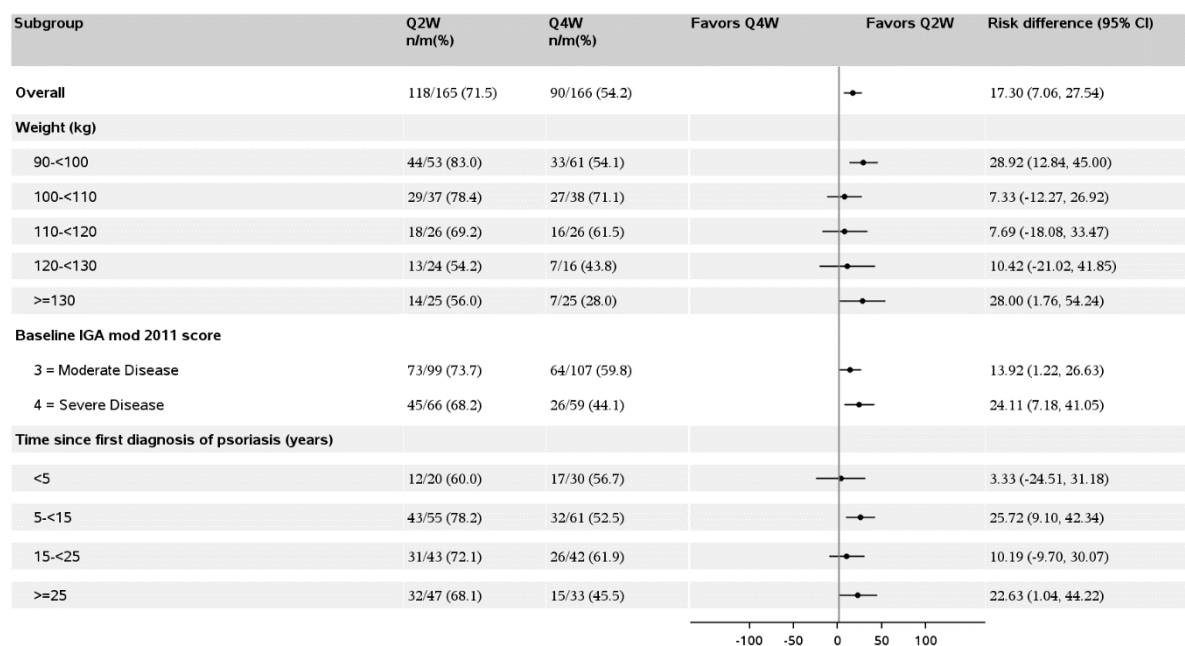

*Figure 2 Forest plot presents risk difference of every 2 week regimen (Q2W) vs. every 4 week regimen (Q4W). The safety profiles of the two dosing regimens, Cosentyx 300 mg administered every 4 weeks and Cosentyx 300 mg administered every 2 weeks, in patients weighing ≥ 90 kg were comparable and consistent with the safety profile reported in psoriasis patients.

Modeling and simulation (from a database of 4,194 patients with weight ranging from 36 to 219 kg) predicted that among patients who do not achieve PASI 90 response at Week 16 with 300 mg every 4 weeks, the regimen of 300 mg every 2 weeks results in an expected increase in the PASI 90 response rate of approximately 20% from Week 16 to 52 in patients ≥ 90 kg, and an expected increase of approximately 15% in patients < 90 kg.

Pediatric patients

Severe plaque psoriasis

A 52-week, randomized, double-blind, placebo and etanercept-controlled phase III study enrolled 162 pediatric patients 6 to less than 18 years of age, with severe plaque psoriasis (as defined by a PASI score ≥ 20 , an IGA mod 2011 score of 4, and involving $\geq 10\%$ of the body surface area) who were candidates for systemic therapy. Approximately 43% had prior exposure to phototherapy, 53% to conventional systemic therapy, 3% to biologics, and 9% had concomitant psoriatic arthritis.

Patients were randomized to receive one of the following four treatments:

- low dose secukinumab (75 mg for body weight <50 kg or 150 mg for body weight ≥50 kg) at Weeks 0, 1, 2, 3, and 4 followed by the same dose every 4 weeks,
- high dose secukinumab (75 mg for body weight <25 kg, 150 mg for body weight ≥25 kg and <50 kg, or 300 mg for body weight ≥50 kg) at Weeks 0, 1, 2, 3, and 4 followed by the same dose every 4 weeks,
- placebo at Weeks 0, 1, 2, 3, and 4 followed by the same dose every 4 weeks
- etanercept (0.8 mg/kg) weekly (up to a maximum of 50 mg).

Patients distribution by weight and age at randomization is described in Table 7.

Table 7 Patient distribution by weight and age

Randomisation strata	Description	Secukinumab low dose n=40	Secukinumab high dose n=40	Placebo n=41	Etanercept n=41	Total N=162
Age	6-<12 years	8	9	10	10	37
	≥12-<18 years	32	31	31	31	125
Weight	<25 kg	2	3	3	4	12
	≥25-<50 kg	17	15	17	16	65
	≥50 kg	21	22	21	21	85

Patients randomized to receive placebo who were non-responders at Week 12 were switched to either the secukinumab low or high dose group (dose based on body weight group) and received study drug at Weeks 12, 13, 14, and 15, followed by the same dose every 4 weeks starting at Week 16.

The co-primary endpoints were the proportion of patients who achieved a reduction in PASI score of at least 75% (PASI 75) and IGA mod 2011 ‘clear’ or ‘almost clear’ (0 or 1) with at least a 2 point improvement from baseline to Week 12. The key secondary endpoint was the proportion of patients who achieved a reduction in PASI score of at least 90% (PASI 90) from baseline to Week 12. Other secondary endpoints included PASI 50, 100 responder rates at Week 12, PASI 50, 75, 90, 100 and IGA 0/1 responder rates at Week 16 and over time up to and including Week 52, change in PASI score over time up to and including Week 52 and IGA score over time up to and including Week 52, the proportion of patients with a Children’s Dermatology Life Quality Index (CDLQI) score of 0 or 1 at Week 12 and over time up to and including Week 52, and change from baseline in CDLQI compared to placebo at Week 12 and over time up to and including Week 52.

During the 12 week placebo-controlled period, the efficacy of both the low and the high dose of secukinumab was comparable for the co-primary endpoints. The odds ratio estimates in favor of both secukinumab doses were clinically relevant and statistically significant for both the PASI 75 and IGA mod 2011 ‘clear’ or ‘almost clear’ (0 or 1) responses.

All patients were followed for efficacy and safety during the 52 weeks following the first dose. The proportion of patients achieving PASI 75 and IGA mod 2011 ‘clear’ or ‘almost clear’ (0 or 1) responses showed separation between secukinumab treatment groups and placebo at the first post-baseline visit at Week 4, the difference becoming more prominent at Week 12. The response was maintained throughout the 52 week time period. Improvement in PASI 50, 90, 100 responder rates and CDLQI 0 or 1 scores were also maintained throughout the 52 week time period.

In addition, PASI 75, IGA 0 or 1, PASI 90 response rates at Weeks 12 and 52 for both secukinumab low and high dose groups were higher than the rates for patients treated with etanercept.

Beyond Week 12, efficacy of both the low and the high dose of secukinumab was comparable although the efficacy of the high dose was higher for patients ≥ 50 kg. The safety profiles of the low dose and the high dose were comparable.

The efficacy results at Weeks 12 and 52 are presented in Table 8

Table 8 Summary of clinical response in severe pediatric psoriasis at Weeks 12* and 52*

Response criterion	Treatment comparison	'test'	'control'	odds ratio estimate (95% CI)	p-value
	'test' vs. 'control'	n/m** (%)	n/m** (%)		
At Week 12***					
PASI 75	secukinumab low dose vs. placebo	32/40 (80.0)	6/41 (14.6)	25.78 (7.08,114.66)	<0.0001
	secukinumab high dose vs. placebo	31/40 (77.5)	6/41 (14.6)	22.65 (6.31,98.93)	<0.0001
	secukinumab low dose vs. etanercept	32/40 (80.0)	26/41 (63.4)	2.25 (0.73,7.38)	
	secukinumab high dose vs. etanercept	31/40 (77.5)	26/41 (63.4)	1.92 (0.64,6.07)	
IGA 0/1	secukinumab low dose vs. placebo	28/40 (70.0)	2/41 (4.9)	51.77 (10.02,538.64)	<0.0001
	secukinumab high dose vs. placebo	24/40 (60.0)	2/41 (4.9)	32.52 (6.48,329.52)	<0.0001
	secukinumab low dose vs. etanercept	28/40 (70.0)	14/41 (34.1)	4.49 (1.60,13.42)	
	secukinumab high dose vs. etanercept	24/40 (60.0)	14/41 (34.1)	2.86 (1.05,8.13)	
PASI 90	secukinumab low dose vs. placebo	29/40 (72.5)	1/41 (2.4)	133.67 (16.83,6395.22)	<0.0001
	secukinumab high dose vs. placebo	27/40 (67.5)	1/41 (2.4)	102.86 (13.22,4850.13)	<0.0001
	secukinumab low dose vs. etanercept	29/40 (72.5)	12/41 (29.3)	7.03 (2.34,23.19)	
	secukinumab high dose vs. etanercept	27/40 (67.5)	12/41 (29.3)	5.32 (1.82,16.75)	
At Week 52					
PASI 75	secukinumab low dose vs. etanercept	35/40 (87.5)	28/41 (68.3)	3.12 (0.91,12.52)	
	secukinumab high dose vs. etanercept	35/40 (87.5)	28/41 (68.3)	3.09 (0.90,12.39)	
IGA 0/1	secukinumab low dose vs. etanercept	29/40 (72.5)	23/41 (56.1)	2.02 (0.73,5.77)	
	secukinumab high dose vs. etanercept	30/40 (75.0)	23/41 (56.1)	2.26 (0.81,6.62)	
PASI 90	secukinumab low dose vs. etanercept	30/40 (75.0)	21/41 (51.2)	2.85 (1.02,8.38)	
	secukinumab high dose vs. etanercept	32/40 (80.0)	21/41 (51.2)	3.69 (1.27,11.61)	

* non-responder imputation was used to handle missing values

** n is the number of responders, m = number of patients evaluable

*** extended visit-window at week 12

Odds ratio, 95% confidence interval, and p-value are from an exact logistic regression model with treatment group, baseline body-weight category and age category as factors

A higher proportion of pediatric patients treated with secukinumab reported improvement in health-related quality of life as measured by a CDLQI score of 0 or 1 compared to placebo at Week 12 (low dose 44.7%, high dose 50%, placebo 15%). From Week 12 through Week 52, the proportion of pediatric patients in both secukinumab dose groups with a CDLQI score of 0 or 1 was numerically higher than for the etanercept group (low dose 60.6%, high dose 66.7%, etanercept 44.4%).

Moderate to severe plaque psoriasis

An open-label, two-arm, parallel-group, multicenter phase III study enrolled 84 pediatric patients 6 to less than 18 years of age with moderate to severe plaque psoriasis (as defined by a PASI score ≥ 12 , an IGA mod 2011 score of ≥ 3 , and involving $\geq 10\%$ of the body surface area) who were candidates for systemic therapy.

Patients were randomized to receive secukinumab at Weeks 0, 1, 2, 3, and 4 followed by the same dose every 4 weeks as follows:

- low dose secukinumab (75 mg for body weight <50 kg or 150 mg for body weight ≥ 50 kg),
- high dose secukinumab (75 mg for body weight <25 kg, 150 mg for body weight between ≥ 25 kg and <50 kg, or 300 mg for body weight ≥ 50 kg).

Patient distribution by weight and age at randomisation is described in Table 9

Table 9 Patient distribution by weight and age

Sub-groups	Description	Secukinumab low dose n=42	Secukinumab high dose n=42	Total N=84
Age	6-<12 years	17	16	33
	≥ 12 -<18 years	25	26	51
Weight	<25 kg	4	4	8
	≥ 25 -<50 kg	13	12	25
	≥ 50 kg	25	26	51

The co-primary endpoints were the proportion of patients who achieved a reduction in PASI score of at least 75% (PASI 75) and IGA mod 2011 ‘clear’ or ‘almost clear’ (0 or 1) with at least a 2 point improvement from baseline to Week 12. Secondary and additional endpoints included PASI 90 response at Week 12, PASI 75, 90, 100, and IGA mod 2011 ‘clear’ or ‘almost clear’ (0 or 1), and CDLQI responses over time up to end of treatment.

The efficacy of both the low and the high dose of secukinumab was comparable and showed statistically and clinically meaningful improvement compared to historical placebo for the co-

primary endpoints. The odds ratio estimates in favor of both secukinumab doses were clinically relevant and statistically significant for both the PASI 75 and IGA mod 2011 0 or 1 responses versus historical placebo. The estimated posterior probability of a positive treatment effect was 100%.

All patients were followed for efficacy for at least 24 weeks following first administration. Efficacy (defined as PASI 75 response and IGA mod 2011 ‘clear’ or ‘almost clear’ [0 or 1]) was observed as early as Week 2 and the proportion of patients who achieved a PASI 75 response and IGA mod 2011 ‘clear’ or ‘almost clear’ (0 or 1) increased throughout the 24-week time period. Improvement in PASI 90 and PASI 100 were also observed at Week 12 and increased throughout the 24-week time period.

Beyond Week 12, efficacy of both the low and the high dose of secukinumab was comparable. The safety profiles of the low dose and the high dose were comparable.

The efficacy results at Weeks 12 and 24 are presented in Table 10.

Table 10 Summary of clinical response in moderate to severe pediatric psoriasis at Weeks 12* and 24* (pediatric psoriasis)

	Week 12		Week 24	
	Secukinumab	Secukinumab	Secukinumab	Secukinumab
	low dose	high dose	low dose	high dose
Number of patients	42	42	42	42
PASI 75 response n (%)	39 (92.9%)	39 (92.9%)	40 (95.2%)	40 (95.2%)
IGA mod 2011 ‘clear’ or ‘almost clear’ response n (%)	33 (78.6%)	35 (83.3%)	37 (88.1%)	39 (92.9%)
PASI 90 response n (%)	29 (69.0%)	32 (76.2%)	37 (88.1%)	37 (88.1%)
PASI 100 response n (%)	25 (59.5%)	23 (54.8%)	28 (66.7%)	28 (66.7%)

* non-responder imputation was used to handle missing values

In the low dose group, 50% and 70.7% of patients achieved a CDLQI 0 or 1 score at Weeks 12 and 24, respectively. In the high dose group, 61.9% and 60.5% achieved a CDLQI 0 or 1 score at Weeks 12 and 24, respectively.

Psoriatic arthritis

Cosentyx has been shown to improve signs and symptoms, physical function and health-related quality of life, and to reduce the rate of progression of peripheral joint damage in adult patients with active PsA.

The safety and efficacy of Cosentyx were assessed in 1,999 patients in three randomized, double blind, placebo-controlled phase III studies in patients with active psoriatic arthritis (≥ 3 swollen and ≥ 3 tender joints) despite non-steroidal anti-inflammatory drug (NSAID), corticosteroids or disease-modifying anti-rheumatic drug (DMARD) therapy. Patients in these studies had a diagnosis of PsA of at least five years. The majority of patients also had active psoriasis skin lesions or a documented history of psoriasis. Over 61% and 42% of the PsA patients had enthesitis and dactylitis at baseline, respectively.

The efficacy and safety of Cosentyx 75 mg, 150 mg and/or 300 mg were evaluated versus placebo with either an i.v. or s.c. loading dose regimen. In Psoriatic Arthritis 1 Study (PsA1 Study), Psoriatic Arthritis 2 Study (PsA2 Study) and Psoriatic Arthritis 3 Study (PsA3 Study), 29%, 35% and 30% of patients, respectively, were previously treated with an anti-TNF-alpha agent and discontinued the anti-TNF-alpha agent for either lack of efficacy or intolerance (anti-TNF-alpha-IR patients).

PsA1 Study (FUTURE 1) evaluated 606 patients, of whom 60.7% had concomitant MTX. Patients with each subtype of PsA were enrolled, including polyarticular arthritis with no evidence of rheumatoid nodules (76.7%), spondylitis with peripheral arthritis (18.5%), asymmetric peripheral arthritis (60.2%), distal interphalangeal involvement (59.6%) and arthritis mutilans (7.9%). Patients randomized to Cosentyx received 10 mg/kg, i.v. at Weeks 0, 2, and 4, followed by either 75 mg or 150 mg s.c. every month starting at Week 8. Patients randomized to receive placebo who were non-responders at Week 16 were then crossed over to receive Cosentyx (either 75 mg or 150 mg) at Week 16 followed by the same dose every month. Patients randomized to receive placebo who were responders at Week 16 were then crossed over to receive Cosentyx (either 75 mg or 150 mg) at Week 24 followed by the same dose every month. The primary endpoint was American College of Rheumatology (ACR) 20 response at Week 24.

PsA2 Study (FUTURE 2) evaluated 397 patients, of whom 46.6% had concomitant MTX. Patients with each subtype of PsA were enrolled, including polyarticular arthritis with no evidence of rheumatoid nodules (85.9%), spondylitis with peripheral arthritis (21.7%), asymmetric peripheral arthritis (64.0%), distal interphalangeal involvement (57.9%) and arthritis mutilans (6.3%). Patients randomized to Cosentyx received 75 mg, 150 mg or 300 mg s.c. at Weeks 0, 1, 2, 3, and 4 followed by the same dose every month. Patients randomized to receive placebo who were non-responders at Week 16 were then crossed over to receive Cosentyx (either 150 mg or 300 mg, s.c.) at Week 16 followed by the same dose every month.

Patients randomized to receive placebo who were responders at Week 16 were crossed over to receive Cosentyx (either 150 mg or 300 mg) at Week 24 followed by the same dose every month. The primary endpoint was ACR 20 response at Week 24.

PsA3 Study (FUTURE 5) evaluated 996 patients, of whom 50.1% had concomitant MTX treatment. Patients with each subtype of PsA were enrolled, including polyarticular arthritis with no evidence of rheumatoid nodules (78.7%), spondylitis with peripheral arthritis (19.8%), asymmetric peripheral arthritis (65%), distal interphalangeal involvement (56.7%) and arthritis mutilans (6.8%). Patients were randomized to receive Cosentyx 150 mg, 300 mg, or placebo s.c. at Weeks 0, 1, 2, 3 and 4 followed by the same dose every month, or a once monthly injection of Cosentyx 150 mg. Patients randomized to receive placebo who were non-responders at Week 16 were then crossed over to receive Cosentyx (either 150 mg or 300 mg, s.c.) at Week 16 followed by the same dose every month. Patients randomized to receive placebo who were responders at Week 16 were crossed over to receive Cosentyx (either 150 mg or 300 mg) at Week 24 followed by the same dose every month. The primary endpoint was ACR 20 response at Week 16, and the key secondary endpoint was the change from baseline in modified Total Sharp Score (mTSS) at Week 24.

Clinical response

Signs and symptoms

Treatment with Cosentyx resulted in significant improvement in the measure of disease activity compared to placebo at Weeks 16, 24, and 52 (see Table 11). These measures include ACR20, ACR50, ACR70, Psoriasis Area and Severity Index (PASI) 75, PASI 90 and Disease Activity Score (DAS28-CRP), Short Form Health Survey - Physical Component Summary (SF36- PCS), Health Assessment Questionnaire – Disability Index (HAQ-DI) response compared to placebo at Weeks 16, 24, and 52 (see Table 11).

Table 11 Clinical response in PsA 2 and PsA3 Studies at Week 16, Week 24, and Week 52

	PsA2			PsA3		
	Placebo	150 mg ¹	300 mg ¹	Placebo	150 mg ¹	300 mg ¹
Number of patients randomized	98	100	100	332	220	222
ACR 20 response n (%)						
Week 16	18 (18.4%)	60 (60.0%***)	57 (57.0%***)	91 [◊] (27.4%)	122 [◊] (55.5%***)	139 [◊] (62.6%***)

	PsA2			PsA3		
	Placebo	150 mg ¹	300 mg ¹	Placebo	150 mg ¹	300 mg ¹
Week 24	15 [◇] (15.3%)	51 [◇] (51.0%***)	54 [◇] (54.0%***)	78 (23.5%)	117 (53.2%***)	141 (63.5%***)
Week 52	-	64 (64.0%)	64 (64.0%)	NA	NA	NA
ACR 50 response n (%)						
Week 16	6 (6.1%)	37 (37.0%***)	35 (35.0%***)	27 (8.1%)	79 (35.9%***)	88 (39.6%***)
Week 24	7 (7.1%)	35 (35.0%***)	35 (35.0%***)	29 (8.7%)	86 (39.1%***)	97 (43.7%***)
Week 52	-	39 (39.0%)	44 (44.0%)	NA	NA	NA
ACR 70 response n (%)						
Week 16	2 (2.0%)	17 (17.0%**)	15 (15.0%**)	14 (4.2%)	40 (18.2%***)	45 (20.3%***)
Week 24	1 (1.0%)	21 (21.0%**)	20 (20.0%**)	13 (3.9%)	53 (24.1%***)	57 (25.7%***)
Week 52	-	20 (20.0%)	24 (24.0%)	NA	NA	NA
DAS28-CRP						
Week 16	-0.50	-1.45***	-1.51***	-0.63	-1.29***	-1.49***
Week 24	-0.96	-1.58***	-1.61***	-0.84	-1.57***	-1.68***
Week 52	-	-1.69	-1.78	NA	NA	NA
Number of patients with ≥ 3% BSA psoriasis skin involvement at baseline	43 (43.9%)	58 (58.0%)	41 (41.0%)	162 (48.8%)	125 (56.8%)	110 (49.5%)
PASI 75 response n (%)						
Week 16	3 (7.0%)	33 (56.9%***)	27 (65.9%***)	20 (12.3%)	75 (60.0%***)	77 (70.0%***)
Week 24	7 (16.3%)	28 (48.3%***)	26 (63.4%***)	29 (17.9%)	80 (64.0%***)	78 (70.9%***)
Week 52	-	33 (56.9%)	30 (73.2%)	NA	NA	NA
PASI 90 response n (%)						
Week 16	3 (7.0%)	22 (37.9%***)	18 (43.9%***)	15 (9.3%)	46 (36.8%***)	59 (53.6%***)
Week 24	4 (9.3%)	19 (32.8%**)	20 (48.8%***)	19 (11.7%)	51 (40.8%***)	60 (54.5%***)
Week 52	-	25 (43.1%)	23 (56.1%)	NA	NA	NA
Dactylitis Resolution n (%) †						
Week 16	10 (37%)	21 (65.6%*)	26 (56.5%)	40 (32.3%)	46 (57.5%***)	54 (65.9%***)
Week 24	4	16	26	42	51	52

	PsA2			PsA3		
	Placebo	150 mg ¹	300 mg ¹	Placebo	150 mg ¹	300 mg ¹
Week 52	(14.8%) -	(50.0%**) 21 (65.6%)	(56.5%**) 32 (69.6%)	(33.9%) NA	(63.8%***) NA	(63.4%***) NA
Enthesitis Resolution n (%) ‡						
Week 16	17 (26.2%)	32 (50.0%**)	32 (57.1%***)	68 (35.4%)	77 (54.6%***)	78 (55.7%***)
Week 24	14 (21.5%)	27 (42.2%*)	27 (48.2%**)	66 (34.4%)	77 (54.6%***)	86 (61.4%***)
Week 52	-	31 (48.4%)	30 (53.6%)	NA	NA	NA

* p<0.05, ** p<0.01, *** p<0.001; versus placebo

All p-values are non-adjusted.

Non-responder imputation used for missing binary endpoint.

NA: Not Available; ACR: American College of Rheumatology; PASI: Psoriasis Area and Severity Index; DAS: Disease Activity Score; BSA: Body Surface Area

¹Primary Endpoint

¹Cosentyx 150 mg or 300 mg s.c. at Weeks 0, 1, 2, 3, and 4 followed by the same dose every month

‡In patients with dactylitis at baseline (n=27, 32, 46 respectively for PsA2 and n=124, 80, 82 respectively for PsA3)

‡In patients with enthesitis at baseline (n=65, 64, 56 respectively for PsA2 and n=192, 141, 140, respectively for PsA3)

The onset of action of Cosentyx occurred as early as Week 2. Statistically significant difference in ACR 20 vs placebo was reached at Week 3. In PsA2 efficacy responses were maintained up to Week 104.

The percentage of patients achieving ACR20 response by visit is shown in Figure 3.

Figure 3 ACR 20 response in PsA 2 Study over time up to Week 24

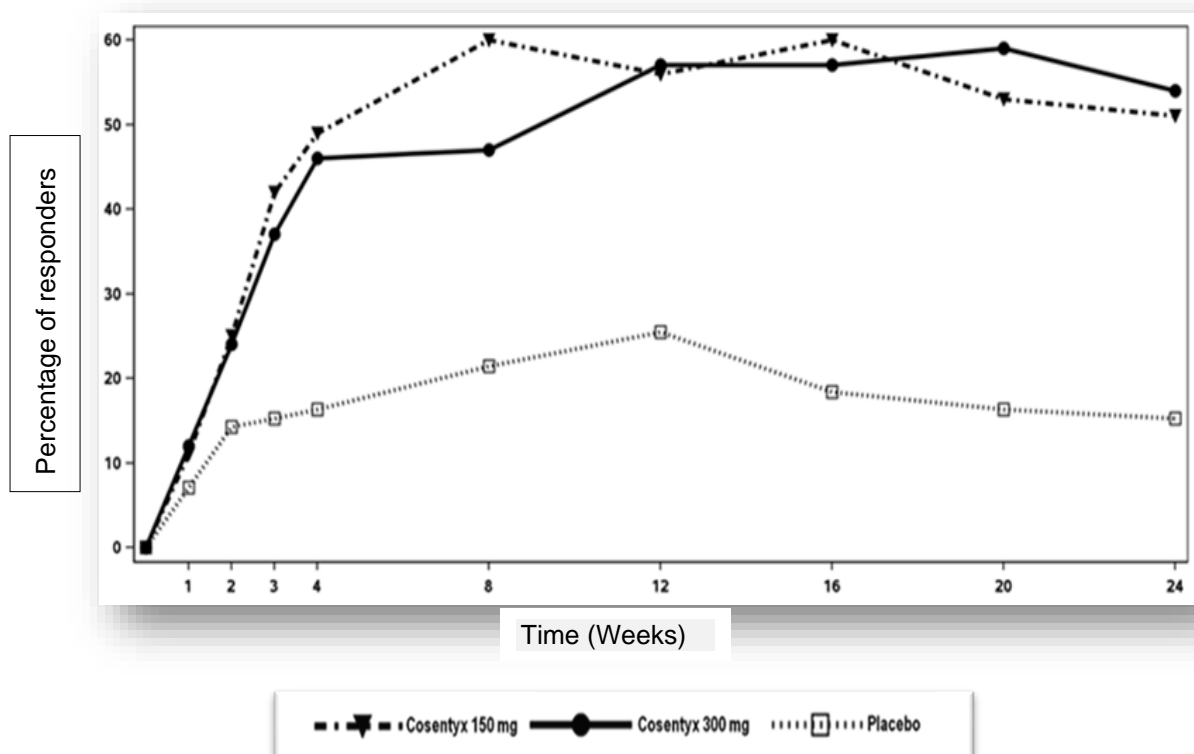

Similar responses for primary and key secondary endpoints were seen in PsA patients regardless of whether they were on concomitant MTX treatment or not.

Both anti-TNF-alpha-naïve and anti-TNF-alpha-IR Cosentyx-treated patients, had a significantly higher ACR 20 response compared to placebo at Weeks 16 and 24, with a slightly higher response in the anti-TNF-alpha-naïve group (In PsA 2 anti-TNF-alpha-naïve: 64% and 58% for 150 mg and 300 mg, respectively, compared to placebo 15.9%; anti-TNF-alpha-IR: 30% and 46% for 150 mg and 300 mg, respectively, compared to placebo 14.3%).

Anti-TNF-alpha-IR patients on 300mg showed higher response rates on ACR20 compared to placebo patients ($p < 0.05$) and demonstrated clinical meaningful benefit over 150 mg on multiple secondary endpoints. Improvements in the PASI75 response were seen regardless of previous anti-TNF-alpha exposure.

In PsA2, the proportion of patients achieving a modified PsA Response Criteria (PsARC) response was greater in the Cosentyx-treated patients (59.0% and 61.0% for 150 mg and 300 mg, respectively) compared to placebo (26.5%) at Week 24.

At Weeks 16 and 24, improvements in parameters of peripheral activity characteristic of psoriatic arthritis (e.g., number of painful/tender joints, dactylitis, enthesitis and modified nail psoriasis severity index (mNAPSI)) were seen in the Cosentyx-treated patients (nominal p-value $p < 0.01$).

The results of the components of the ACR response criteria are shown in Table 12.

Table 12 Mean change from baseline in ACR components for PsA 2 Study at Week 24

	Placebo (N=98)	150 mg (N=100)	300 mg (N=100)
No. of swollen joints			
Baseline	12.1	11.9	11.2
Mean change at Week 24	-5.14	-6.32	-7.28*
Number of tender joints			
Baseline	23.4	24.1	20.2
Mean change at Week 24	-4.28	-11.42***	-10.84**
Patient's assessment of pain			
Baseline	55.4	58.9	57.7
Mean change at Week 24	-11.71	-23.39**	-22.35**
Patient global assessment			
Baseline	57.6	62.0	60.7

Mean change at Week 24	-10.14	-25.78***	-26.70***
Physician global assessment			
Baseline	55.0	56.7	55.0
Mean change at Week 24	-25.23	-32.97*	-38.52***
Disability Index (HAQ)			
Baseline	1.1684	1.2200	1.2828
Mean change at Week 24	-0.31	-0.48*	-0.56**
CRP (mg/dL),			
Baseline	7.71	14.15	10.69
Mean change at Week 24	-0.75	-0.55*	-0.55*
* p<0.05, ** p<0.01, *** p<0.001 based on nominal, but not adjusted, p-value			

In PsA1 Study, Cosentyx-treated patients demonstrated significantly improved PsA signs and symptoms at Week 24 with similar magnitude of response to PsA2 Study. Efficacy was maintained up to Week 104.

Radiographic response

In PsA3 Study, structural damage was assessed radiographically and expressed by the modified Total Sharp Score (mTSS) and its components, the Erosion Score (ES) and the Joint Space Narrowing Score (JSN). Radiographs of hands, wrists, and feet were obtained at baseline Week 16 and/or Week 24 and scored independently by at least two readers who were blinded to treatment group and visit number.

Cosentyx 150 mg and 300 mg treatment significantly inhibited the rate of progression of peripheral joint damage compared with placebo treatment as measured by change from baseline in mTSS at Week 24 (Table 13).

The percentage of patients with no disease progression (defined as a change from baseline in mTSS of ≤ 0.5) from randomization to Week 24 was 79.8%, 88.0% and 73.6% for Cosentyx 150 mg, 300 mg and placebo, respectively. An effect of inhibition of structural damage was observed irrespective of concomitant MTX use or TNF status.

Structural damage was also assessed in the PsA1 Study. Radiographs of hands, wrists, and feet were obtained at baseline and Week 24 during the double-blind period when patients were on Cosentyx or placebo and at Week 52 when all patients were on open-label Cosentyx.

By Week 24, Cosentyx 150 mg treatment significantly inhibited the rate of progression of peripheral joint damage compared with placebo treatment as measured by change from baseline in mTSS (see Table 13). Inhibition of structural damage was maintained with Cosentyx treatment up to Week 52.

Table 13 Change in modified Total Sharp Score in PsA3 and PsA1 Studies

	PsA3			PsA1	
	Placebo n=296	150 mg ¹ n=213	300 mg ¹ n=217	Placebo n= 179	150 mg ² n= 185
Total Score					
Baseline	15.0	13.6	12.9	28.4	22.3
(SD)	(38.2)	(25.9)	(23.7)	(63.5)	(48.0)
Mean Change at Week 24	0.5	0.17*	0.08*	0.57	0.13*
Erosion Score					
Baseline	8.91	7.74	7.39	16.29	12.44
(SD)	(22.0)	(13.9)	(13.8)	(37.4)	(27.39)
Mean Change at Week 24	0.34	0.12*	0.05*	0.35	0.04*
Joint Space Narrowing Score					
Baseline	6.05	5.85	5.46	12.16	9.82
(SD)	(16.6)	(13.3)	(10.7)	(26.66)	(21.29)
Mean Change at Week 24	0.15	0.05	0.03	0.23	0.10

* $p < 0.05$ based on nominal, but not adjusted, p -value

¹ Cosentyx 150 mg or 300 mg s.c. at Weeks 0, 1, 2, 3, and 4 followed by the same dose every month

² 10 mg/kg at Weeks 0, 2 and 4 followed s.c. doses of 75 mg or 150 mg

In PsA1, radiographic inhibition was observed in both anti-TNF-alpha-naïve and anti-TNF-alpha-IR patients. Similar effect of inhibition of structural damage was observed irrespective of concomitant MTX use. Inhibition of structural damage was maintained with Cosentyx treatment up to Week 104.

Placebo patients who switched to 75 mg or 150 mg every 4 weeks demonstrated inhibition of structural damage from Week 16 or 24 to Week 52 (Change in mTSS -0.03).

The percentage of patients with no-disease progression (defined as a change from baseline in mTSS of ≤ 0.5) from randomization to Week 24 was 82.3% in secukinumab 10 mg/kg i.v. load – 150 mg s.c. maintenance and 75.7% in placebo. The percentage of patients with no-disease progression, from Week 24 to Week 52, for the same above described regimen, was 85.7% and 86.8%, respectively.

Axial manifestations in PsA

A randomized, double-blind, placebo-controlled study (MAXIMISE) assessed the efficacy of secukinumab in 485 PsA patients with axial manifestations who were naive to biologic treatment and responded inadequately to NSAIDs. The primary variable was at least a 20% improvement in Assessment of Spondyloarthritis International Society (ASAS 20) criteria at Week 12. Treatment with secukinumab 300 mg and 150 mg compared to placebo resulted in

significant improvement in signs and symptoms (including greater decreases from baseline in spinal pain) and improvement in physical function (see Table 14).

Table 14 Clinical response on MAXIMISE Study at Week 12

	Placebo (n=164)	150 mg (n=157)	300 mg (n=164)
ASAS 20 response, %	31.2	66.3*	62.9*
ASAS 40 response, %	12.2	39.5*	43.6*
BASDAI 50, %	9.8	32.7*	37.4*
Spinal pain, VAS	-13.6	-28.5*	-26.5*
Physical function, HAQDI	-0.155	-0.330**	-0.389*

* $p < 0.0001$; ** $p < 0.0005$; versus placebo

ASAS: Assessment of SpondyloArthritis International Society Criteria; BASDAI: Bath Ankylosing Spondylitis Disease Activity Index; VAS: Visual Analog Scale; HAQDI: Health Assessment Questionnaire – Disability Index

Improvement in ASAS 20 and ASAS 40 for both secukinumab doses were observed by Week 4 and were maintained up to 52 weeks

Physical function and health related quality of life

In PsA2 and PsA3 Studies, patients treated with Cosentyx 150 mg and 300 mg showed improvement in physical function compared to patients treated with placebo as assessed by Health Assessment Questionnaire-Disability Index (HAQ-DI) at Week 24 and 16, respectively. The proportion of patients on 150 mg or 300 mg who achieved a minimal clinically important difference (MCID) of ≥ 0.3 improvement in HAQ-DI score from baseline was greater compared to placebo at Week 16 (PsA3: 54.8%, 62.3% vs. 35.6%; $p < 0.0001$) and Week 24 (PsA2: 46.0%, 49.0% vs. 16.3%, $p < 0.0001$) and the response in PsA 2 was maintained up to Week 104. Improvements in HAQ-DI scores were seen regardless of previous anti-TNF-alpha exposure.

There was greater improvement in Dermatology Life Quality Index (DLQI) scores in the Cosentyx groups as compared to placebo at Week 24 ($p < 0.01$). There was also greater improvement in Functional Assessment of Chronic Illness Therapy – Fatigue (FACIT-F) scores in the 150 mg and 300 mg Cosentyx groups when compared to placebo at Week 24 ($p < 0.01$), and these improvements were maintained up to Week 104 in PsA2. Cosentyx-treated patients reported significant improvements in health-related quality of life as measured by the Short Form (36) Health Survey Physical Component Summary (SF-36 PCS) score ($p < 0.001$). Improvements were also seen for EQ-5D. In addition, improvements were seen in the psoriatic arthritis QoL (PsAQoL $p < 0.01$) and in psoriatic arthritis-related productivity at work and within household, as reported by the Work Productivity and Activity Impairment–General Health questionnaire (WPAI-GH) compared to placebo at Week 24.

In PsA1 Study, Cosentyx-treated patients significantly improved physical function as assessed by HAQ-DI and SF-36 Physical Components at Week 24. Improvements were also seen in SF-36 Mental Component, FACIT-F, PsAQoL and WPAI-GH. Efficacy was maintained up to Week 52.

Axial spondyloarthritis (axSpA) with or without radiographic damage

Ankylosing spondylitis (AS)/axSpA with radiographic damage

The safety and efficacy of Cosentyx were assessed in 816 patients in three randomized, double-blind, placebo-controlled phase III studies in patients with active ankylosing spondylitis (AS) with a Bath Ankylosing Spondylitis Disease Activity Index (BASDAI) ≥ 4 despite non-steroidal anti-inflammatory drug (NSAID), corticosteroid or disease-modifying anti-rheumatic drug (DMARD) therapy. Patients in the AS1 Study and AS2 Study had a diagnosis of AS for a median of 2.7 to 5.8 years.

The efficacy and safety of Cosentyx 75 mg, 150 mg and 300 mg were evaluated versus placebo with either an i.v. or s.c. loading regimen. In Ankylosing Spondylitis 1 Study (AS1 Study), Ankylosing Spondylitis 2 Study (AS2 Study), and Ankylosing Spondylitis 3 Study (AS3 Study), 27.0%, 38.8% and 23.5% of patients, respectively, were previously treated with an anti-TNF-alpha agent and discontinued the anti-TNF-alpha agent for either lack of efficacy or intolerance (anti-TNF-alpha-IR patients).

AS1 Study (MEASURE 1) evaluated 371 patients, of whom 14.8% and 33.4% used concomitant MTX or sulfasalazine, respectively. Patients randomized to Cosentyx received 10 mg/kg, i.v. at Weeks 0, 2, and 4, followed by either 75 mg or 150 mg s.c. every month. Patients randomized to receive placebo who were non-responders at Week 16 were crossed over to receive Cosentyx (either 75 mg or 150 mg) at Week 16, followed by the same dose every month. Patients randomized to receive placebo who were responders at Week 16 were crossed over to receive Cosentyx (either 75 mg or 150 mg) at Week 24, followed by the same dose every month. The primary end point was at least a 20% improvement in Assessment of Spondyloarthritis International Society (ASAS20) criteria at Week 16.

AS2 Study (MEASURE 2) evaluated 219 patients, of whom 11.9% and 14.2% used concomitant MTX or sulfasalazine, respectively. Patients randomized to Cosentyx received 75 mg or 150 mg s.c. at Weeks 0, 1, 2, 3, and 4 followed by the same dose every month. At Week 16, patients who were randomized to placebo at baseline were re-randomized to receive Cosentyx (either 75 mg or 150 mg) s.c. every month. The primary end point was ASAS 20 at Week 16.

AS3 Study (MEASURE 3) evaluated 226 patients, of whom 13.3% and 23.5% used concomitant MTX or sulfasalazine, respectively. Patients randomized to Cosentyx received 10 mg/kg, i.v. at Weeks 0, 2, and 4, followed by either 150 mg or 300 mg s.c. every month. At Week 16, patients who were randomized to placebo at baseline were re-randomized to receive Cosentyx (either 150 mg or 300 mg) s.c. every month. The primary end point was ASAS20 at Week 16. Patients were blinded to the treatment regimen up to Week 52, and the study continued to Week 156.

Clinical response

Signs and symptoms

In AS2 Study, treatment with Cosentyx 150 mg resulted in greater improvement in ASAS20, ASAS40, high-sensitivity C-reactive protein (hsCRP), ASAS 5/6 and BASDAI score compared with placebo at Week 16 (see Table 15).

Table 15 Clinical response in AS2 Study at Week 16

Outcome (p-value vs placebo)	Placebo (n = 74)	75 mg (n = 73)	150 mg (n = 72)
Efficacy at Week 16			
ASAS20 response, %	28.4	41.1	61.1***
ASAS40 response, %	10.8	26.0	36.1***
hsCRP, (post-BSL/BSL ratio)	1.13	0.61	0.55***
ASAS5/6, %	8.1	34.2	43.1***
BASDAI, LS mean change from baseline score	-0.85	-1.92	-2.19***
ASAS partial remission, %	4.1	15.1	13.9
BASDAI50, %	10.8	24.7*	30.6**
ASDAS-CRP major improvement	4.1	15.1*	25.0***
<p>*$p < 0.05$; **$p < 0.01$; ***$p < 0.001$ vs. placebo All p-values adjusted for multiplicity of testing based on pre-defined hierarchy, except BASDAI50 and ASDAS-CRP Non-responder imputation used for missing binary endpoint ASAS: Assessment of SpondyloArthritis International Society Criteria; BASDAI: Bath Ankylosing Spondylitis Disease Activity Index; hsCRP: high-sensitivity C-reactive protein; ASDAS: Ankylosing Spondylitis Disease Activity Score; BSL: baseline; LS: least square</p>			

The results of the main components of the ASAS20 response criteria are shown in Table 16.

Table 16 Main components of the ASAS20 response criteria at baseline and Week 16 in AS 2 Study

ASAS20 Response criteria	Placebo (N = 74)		75 mg (N = 73)		150 mg (N = 72)	
	Baseline	Week16	Baseline	Week16	Baseline	Week16
-Patient global assessment (0-10)	7.0	5.5	6.5	4.5	6.7	3.8
-Total spinal pain (0-10)	6.9	5.7	6.5	4.6	6.6	3.7
-BASFI (0-10)	6.1	5.3	6.0	4.1	6.2	3.8
-Inflammation (0-10)	6.5	5.7	6.9	4.4	6.5	4.0

The onset of action of Cosentyx 150 mg occurred as early as Week 1 for ASAS20 (superior to placebo) in AS2 Study. The percentage of patients achieving an ASAS20 response by visit is shown in Figure 4.

Figure 4 ASAS20 responses in AS 2 Study over time up to Week 16

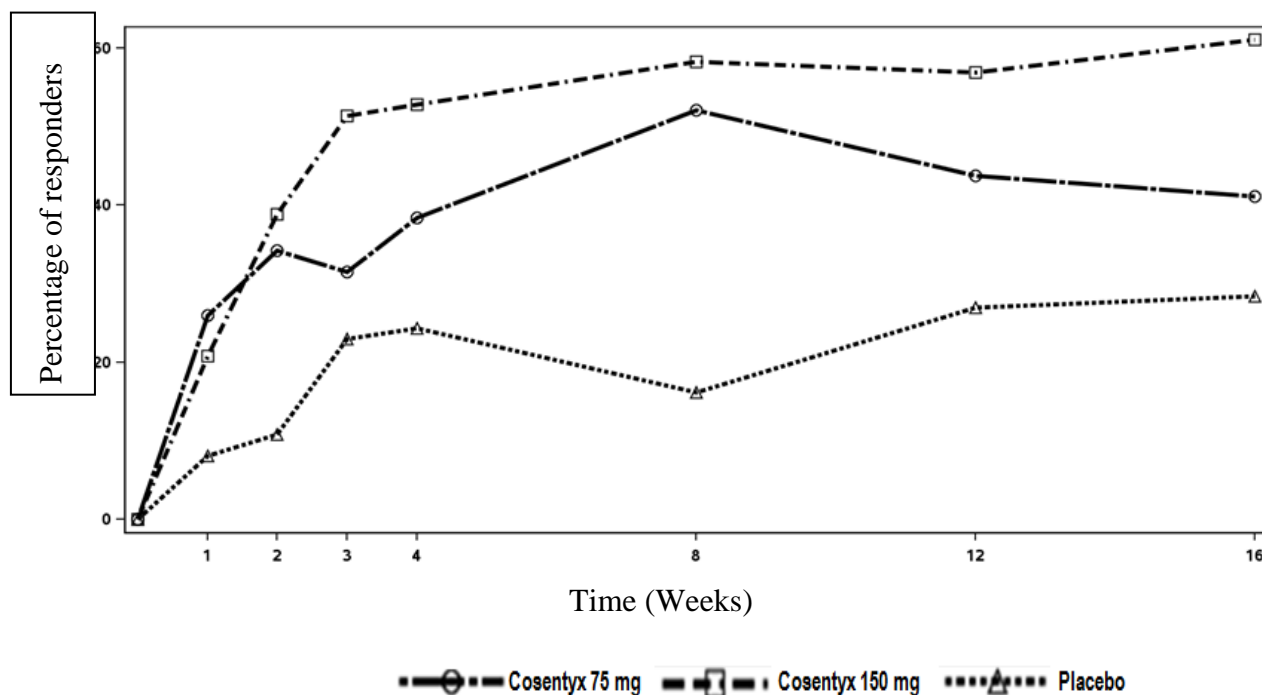
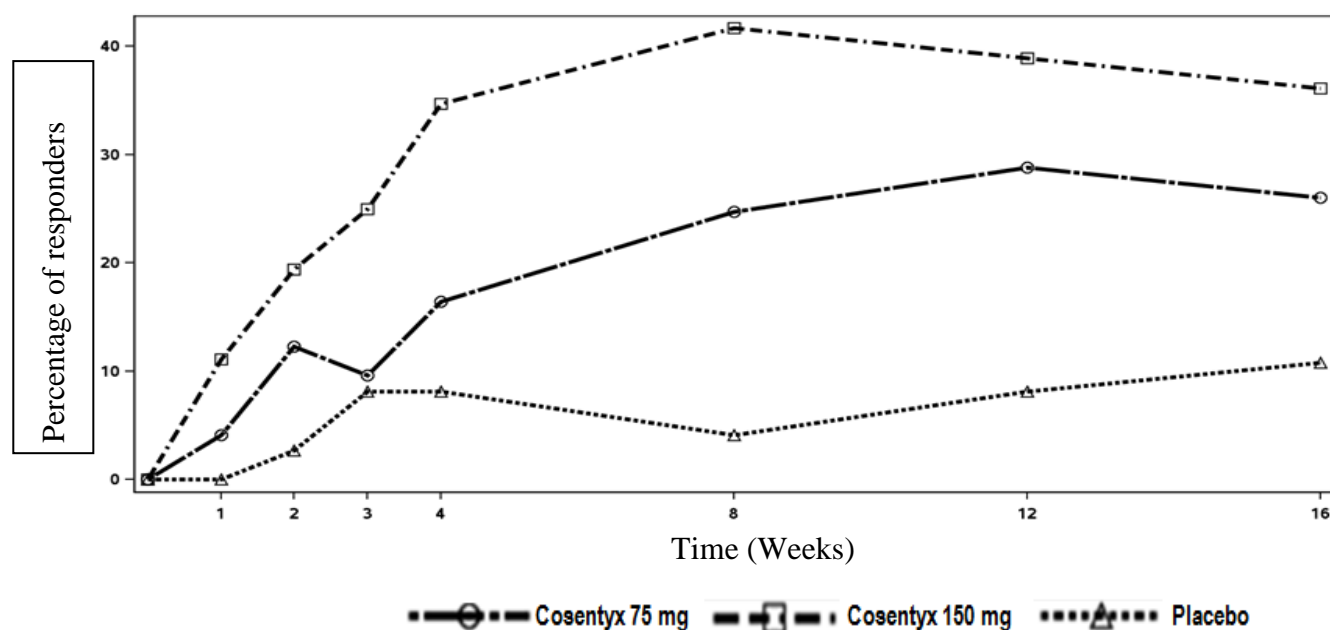

Figure 5 ASAS40 responses in AS 2 Study over time up to Week 16



ASAS20 responses were improved at Week 16 in both anti-TNF-alpha-naïve patients (68.2% vs. 31.1%; $p < 0.05$) and anti-TNF-alpha-IR patients (50.0% vs. 24.1%; $p < 0.05$) for Cosentyx 150 mg compared with placebo, respectively.

In AS1 Study and AS2 Study, Cosentyx-treated patients (150 mg in AS2 Study and both regimens in AS1 Study) demonstrated significantly improved signs and symptoms at Week 16, with comparable magnitude of response and efficacy maintained up to Week 52 in both anti-TNF-alpha-naïve and anti-TNF-alpha-IR patients. In AS2 Study, among 72 patients initially randomised to Cosentyx 150 mg, 61 (84.7%) patients were still on treatment at Week 52. Of the 72 patients randomised to Cosentyx 150 mg, 45 and 35 had an ASAS 20/40 response, respectively.

In AS3 Study, Cosentyx treated patients (150 mg and 300 mg) demonstrated improved signs and symptoms, and had comparable efficacy responses regardless of dose that were superior to placebo at Week 16 for the primary endpoint (ASAS20). Overall, the efficacy response rates for the 300 mg group were consistently greater compared to the 150 mg group for the secondary endpoints. During the blinded period, the ASAS20 and ASAS40 responses were 69.7% and 47.6% for 150 mg and 74.3% and 57.4% for 300 mg at Week 52, respectively. The ASAS20 and ASAS40 responses were maintained through Week 156 (69.5% and 47.6% for 150 mg vs. 74.8% and 55.6% for 300 mg). The ASAS partial remission (ASAS PR) responses were 9.5% and 21.1% for 150 mg and 300 mg respectively, compared to 1.3% for placebo at Week 16. The ASAS PR responses were 18.1% and 24.3% for 150 mg and 300 mg at Week 52,

respectively. These responses were maintained through Week 156 (15.1% for 150 mg and 27.2% for 300 mg).

Spinal mobility

Spinal mobility was assessed by BASMI up to Week 52. In AS2 Study (150 mg) and in AS1 Study (75mg and 150 mg), numerically greater improvements in each BASMI component were demonstrated in Cosentyx-treated patients compared with placebo-treated patients at Weeks 4, 8, 12, and 16 (except for lateral lumbar flexion in patients on 75 mg following the IV load at Weeks 4, 8, and 12).

Physical function and health-related quality of life

In AS2 Study, patients treated with Cosentyx 150 mg showed improvements by Week 16 compared to placebo-treated patients in physical function as assessed by the BASFI (-2.15 vs -0.68, $p < 0.0001$) and in pain as assessed by the Total and Nocturnal Back Pain scale (-29.64 vs -9.64, $p < 0.0001$). Cosentyx-treated patients reported improvements compared to placebo-treated patients in tiredness (fatigue) as reported at Week 16 by scores on the Functional Assessment of Chronic Illness Therapy-Fatigue (FACIT-Fatigue) scale and in health-related quality of life as measured by ASQoL (LS mean change: -4.00 vs -1.37, $p < 0.001$) and SF-36 Physical Component Summary (SF-36 PCS) (LS mean change: 6.06 vs 1.92, $p < 0.001$). Cosentyx 150 mg had numerically larger mean improvements than placebo for three of the four Work Productivity and Activity Impairment-General Health (WPAI-GH) outcomes at Week 16. These improvements were sustained up to Week 52.

In AS1 Study, Cosentyx-treated patients reported improvement in physical function compared to placebo-treated patients at Week 16, as assessed by the BASFI, Total and Nocturnal Back Pain scale, FACIT-Fatigue, ASQoL, EQ-5D and SF-36 Physical Component Summary. Numerically greater increases in work productivity as measured with the WPAI-GH were also observed at Week 16 (tests of significance not performed). These improvements in physical function were all sustained up to Week 52.

Inhibition of inflammation in magnetic resonance imaging (MRI)

In an imaging sub-study including 105 anti-TNF-alpha-naïve patients in AS1 Study, signs of inflammation were assessed by MRI at baseline and Week 16 and expressed as change from baseline in Berlin SI-joint edema score for sacroiliac joints and ASspiMRI-a score and Berlin spine score for the spine. Inhibition of inflammatory signs in both sacroiliac joints and the spine was observed in secukinumab-treated patients.

Non-radiographic axial spondyloarthritis (nr-axSpA) / axSpA without radiographic damage

The safety and efficacy of Cosentyx were assessed in 555 patients in one randomized, double-blind, placebo-controlled phase III study in patients with active non-radiographic axial spondyloarthritis (nr-axSpA) fulfilling the Assessment of Spondyloarthritis International Society (ASAS) classification criteria for axial spondyloarthritis (axSpA) with no radiographic evidence of changes in the sacroiliac joints that would meet the modified New York criteria for ankylosing spondylitis (AS). Patients enrolled had active disease, defined as a Bath Ankylosing Spondylitis Disease Activity Index (BASDAI) ≥ 4 , a Visual Analogue Scale (VAS) for total back pain of ≥ 40 (on a scale of 0-100 mm), despite current or previous non-steroidal anti-inflammatory drug (NSAID) therapy and increased C-reactive protein (CRP) and/or evidence of sacroiliitis on Magnetic Resonance Imaging (MRI). Patients in this study had a diagnosis of axSpA for a median of 2.1 to 3.0 years and 54% of the study participants were female.

In nr-axSpA 1 Study, 57.6% of patients had increased CRP, 72.2% had evidence of sacroiliitis on MRI and 29.9% had both increased CRP and evidence of sacroiliitis on MRI. In addition, 9.7% of patients were previously treated with an anti-TNF-alpha agent and discontinued the anti-TNF-alpha agent for either lack of efficacy or intolerance (anti-TNF-alpha-IR patients).

Nr-axSpA 1 Study (PREVENT) evaluated 555 patients, of whom 9.9% and 14.8% used concomitant MTX or sulfasalazine, respectively. In the double-blind period, patients received either placebo or Cosentyx for 52 weeks. Patients randomized to Cosentyx received 150 mg s.c. at Weeks 0, 1, 2, 3 and 4 followed by the same dose every month, or a once monthly injection of Cosentyx 150 mg. The primary endpoint was at least 40% improvement in ASAS 40 at Week 16 in TNF-naive patients.

Clinical response

Signs and symptoms

In nr-axSpA1 Study, treatment with Cosentyx 150 mg resulted in significant improvements in the measures of disease activity compared to placebo at Week 16. These measures include ASAS 40, ASAS 5/6, BASDAI score, BASDAI 50, high-sensitivity CRP (hsCRP), ASAS 20 and ASAS partial remission response compared to placebo at Week 16 (Table 17).

Table 17 Clinical response in nr-axSpA1 Study at Week 16

Outcome (p-value vs placebo)	Placebo	150 mg ¹
Number of TNF-naive patients randomized	171	164
ASAS 40 response, %	29.2%	41.5%*
Total number of patients randomized	186	185
ASAS 40 response, %	28.0%	40.0%*
ASAS 5/6, %	23.7%	40.0%**
BASDAI, LS mean change from baseline score	-1.46	-2.35**
BASDAI 50, %	21.0%	37.3%**
hsCRP, (post-BSL/BSL ratio)	0.91	0.64**
ASAS 20 response, %	45.7%	56.8%*
ASAS partial remission, %	7.0%	21.6%**

*p<0.05; **p< 0.001 vs. placebo
 All p-values adjusted for multiplicity of testing based on pre-defined hierarchy
 Non-responder imputation used for missing binary endpoint
¹Cosentyx 150 mg s.c. at Weeks 0, 1, 2, 3, and 4 followed by the same dose every month
 ASAS: Assessment of SpondyloArthritis International Society Criteria; BASDAI: Bath Ankylosing Spondylitis Disease Activity Index; hsCRP: high-sensitivity C-reactive protein; BSL: baseline; LS: least square

The results of the main components of the ASAS40 response criteria are shown in Table 18.

Table 18 Main components of the ASAS40 response criteria and other measures of disease activity in nr-axSpA patients at baseline and Week 16 in nr-axSpA1 Study

	Placebo (N = 186)		150 mg Load (N = 185)		150 mg No Load (N = 184)	
	Baseline	Week 16 change from baseline	Baseline	Week 16 change from baseline	Baseline	Week 16 change from baseline
ASAS40 Response criteria						
-Patient global assessment of Disease Activity (0-100mm)	68.8	-13.78	72.6	-24.10	71.0	-26.17
-Total back pain (0-100mm)	70.9	-15.64	73.3	-24.96	72.0	-25.52
-BASFI (0-10)	5.893	-1.01	6.244	-1.75	5.922	-1.64
-Inflammation (0-10)	6.588	-1.71	7.206	-2.76	6.827	-2.84
hsCRP (mg/L) Mean Change at Week 16	10.76	-2.42	13.17	-7.90	9.67	-4.67
BASDAI (0-10)	6.760	-1.46	7.082	-2.35	6.931	-2.43
- Spinal pain	7.52	-2.03	7.76	-3.00	7.62	-2.98
- Peripheral pain and swelling (0-10)	6.13	-1.60	6.29	-2.26	6.55	-2.42
BASMI	2.765	-0.13	2.923	-0.26	2.772	-0.27

The onset of action of Cosentyx 150 mg occurred as early as Week 3 for ASAS 40 in anti-TNF-alpha naive patients (superior to placebo) in nr-axSpA1 Study. The percentage of patients achieving an ASAS 40 response in anti-TNF-alpha naive patients by visit is shown in Figure 6. Patients treated with Cosentyx maintained their response compared to placebo up to Week 52.

Figure 6 ASAS 40 responses in anti-TNF-alpha naive patients in nr-axSpA1 Study over time up to Week 16

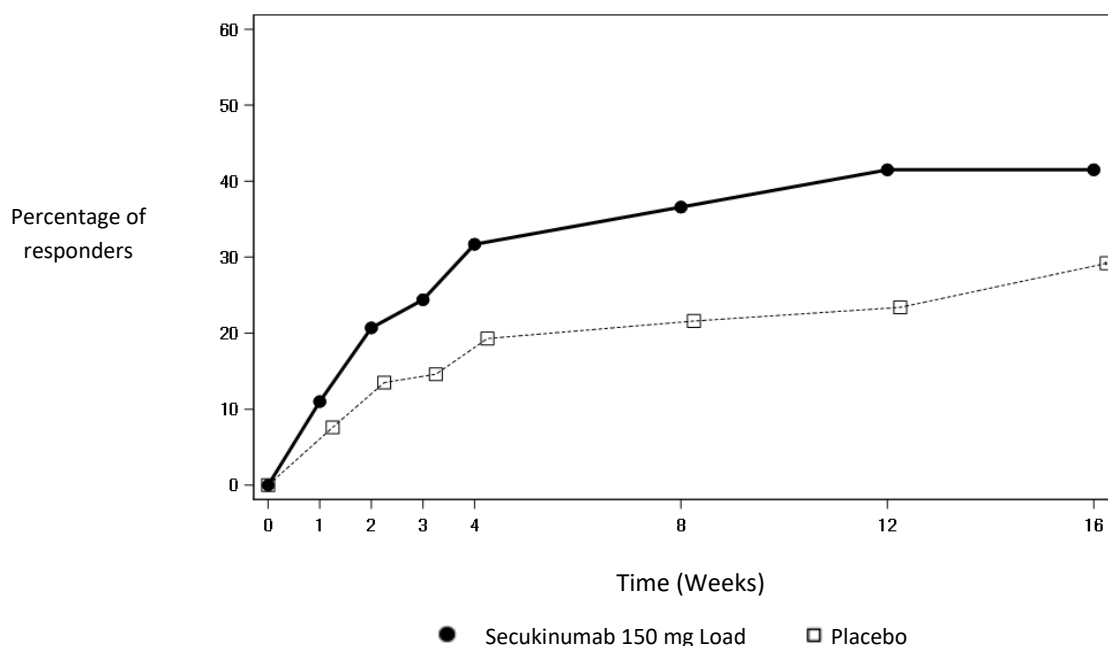

ASAS 40 responses were also improved at Week 16 in anti-TNF-alpha-IR patients (28.6% vs. 13.3%) for Cosentyx 150 mg compared with placebo. The magnitude of response (treatment difference versus placebo) with respect to signs and symptoms at Week 16 was similar in anti-TNF-alpha-naïve and anti-TNF-alpha-IR patients, with higher absolute response rates in anti-TNF-alpha-naïve patients. Efficacy versus placebo was maintained in anti-TNF-alpha-naïve and anti-TNF-alpha-IR patients up to Week 52.

Physical function and health-related quality of life

Patients treated with Cosentyx 150 mg showed statistically significant improvements by Week 16 compared to placebo-treated patients in physical function as assessed by the BASFI (Week 16: -1.75 vs -1.01, $p < 0.01$). Patients treated with Cosentyx reported significant improvements compared to placebo-treated patients by Week 16 in health-related quality of life as measured by ASQoL (LS mean change: Week 16: -3.45 vs -1.84, $p < 0.001$) and SF-36 Physical Component Summary (SF-36 PCS) (LS mean change: Week 16: 5.71 vs 2.93, $p < 0.001$). These improvements were sustained up to Week 52.

Spinal mobility

Spinal mobility was assessed by BASMI up to Week 16. Numerically greater improvements were demonstrated in patients treated with Cosentyx compared with placebo-treated patients at Weeks 4, 8, 12 and 16.

Inhibition of inflammation in magnetic resonance imaging (MRI)

Signs of inflammation were assessed by MRI at baseline and Week 16 and expressed as change from baseline in Berlin SI-joint edema score for sacroiliac joints and ASspiMRI-a score and Berlin spine score for the spine. Inhibition of inflammatory signs in both sacroiliac joints and the spine was observed in patients treated with secukinumab. Mean change from baseline in Berlin SI-joint edema score was -1.68 for patients treated with Cosentyx 150 mg (n=180) versus -0.39 for the placebo-treated patients (n=174) (p<0.0001).

Juvenile Idiopathic Arthritis (JIA)

Enthesitis-Related Arthritis (ERA) and Juvenile Psoriatic Arthritis (JPsA)

The efficacy and safety of secukinumab were assessed in 86 patients in a 3-part, double-blind, placebo-controlled, event-driven, randomized, Phase III study in patients 2 to < 18 years of age with active ERA or JPsA as diagnosed based on a modified International League of Associations for Rheumatology (ILAR) JIA classification criteria. The study consisted of an open-label portion (Part 1), followed by randomized withdrawal (Part 2), followed by open-label treatment (Part 3). The JIA patient subtypes at study entry were: 60.5% ERA and 39.5% JPsA, who either had inadequate response or were intolerant to ≥ 1 disease-modifying antirheumatic drugs (DMARDs) and ≥ 1 non-steroidal anti-inflammatory drugs (NSAID). In the study 67.6% of patients with JPsA, and 63.5% of patients with ERA, were treated concomitantly with MTX. Patients were given a dose of 75 mg if weighing < 50 kg, or 150 mg if weighing ≥ 50 kg.

The primary endpoint was time to flare in Part 2. Disease flare was defined as a $\geq 30\%$ worsening in at least three of the six JIA ACR response criteria and $\geq 30\%$ improvement in not more than one of the six JIA ACR response criteria and a minimum of two active joints.

In open-label Part 1, all patients received secukinumab until Week 12. Patients classified as responders at Week 12 entered into the Part 2 double-blind phase and were randomized 1:1 to continue treatment with secukinumab or begin treatment with placebo. At the end of Part 1, 75 out of 86 patients (90.4%) demonstrated a JIA ACR 30 response and entered into Part 2. Similar responses were seen in each JIA subtype (JPsA and ERA) (Figure 6). At Week 12, 86.7%, 69.9%, and 39.8% of patients were JIA ACR 50, 70, and 90 responders, respectively. Also at Week 12, 36.1% of children had inactive disease based on ACR criteria. The onset of action of secukinumab occurred as early as Week 1. The mean decrease from baseline in Juvenile Arthritis Disease Activity Score (JADAS)-27 was -10.487 (SD: 6.20).

Figure 7 JIA ACR 30 response for all patients and each JIA category up to Week 12 – Part 1

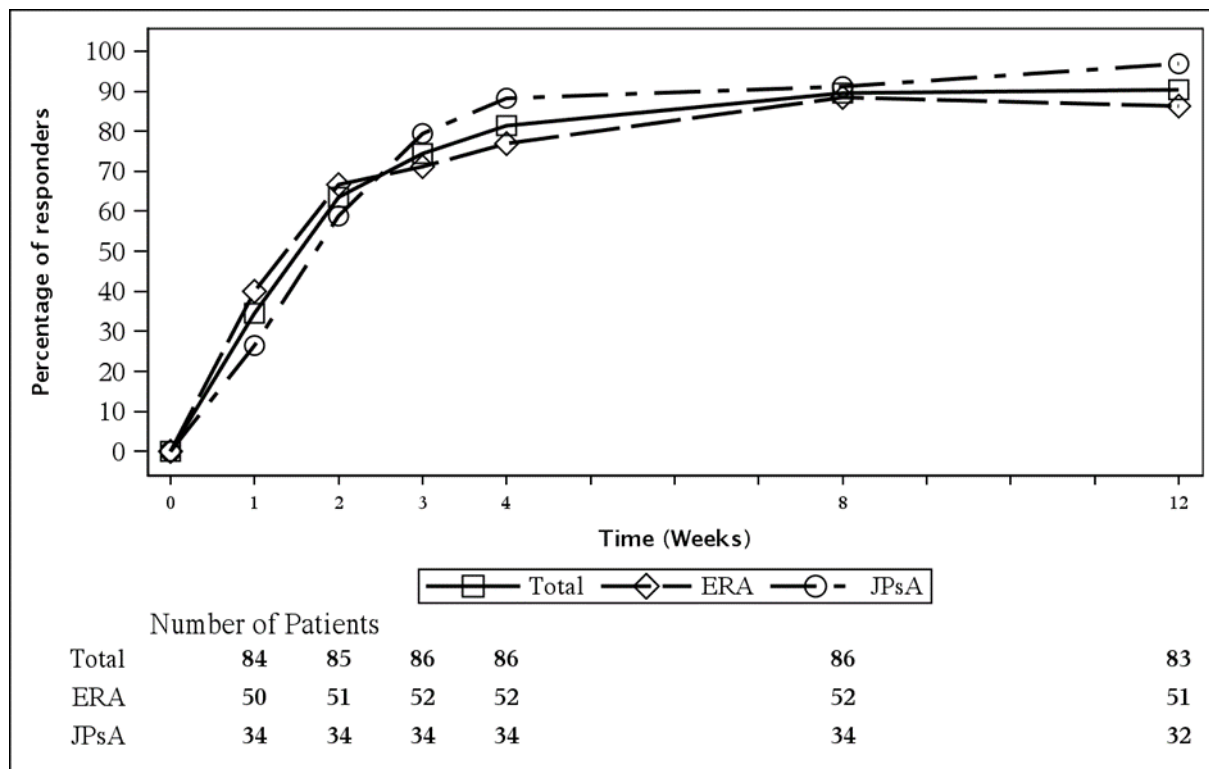

Up to Week 12, all JIA ACR components demonstrated clinically relevant improvement from baseline (see Figure 8).

Figure 8 Improvement from baseline for JIA ACR components up to Week 12 in Part 1

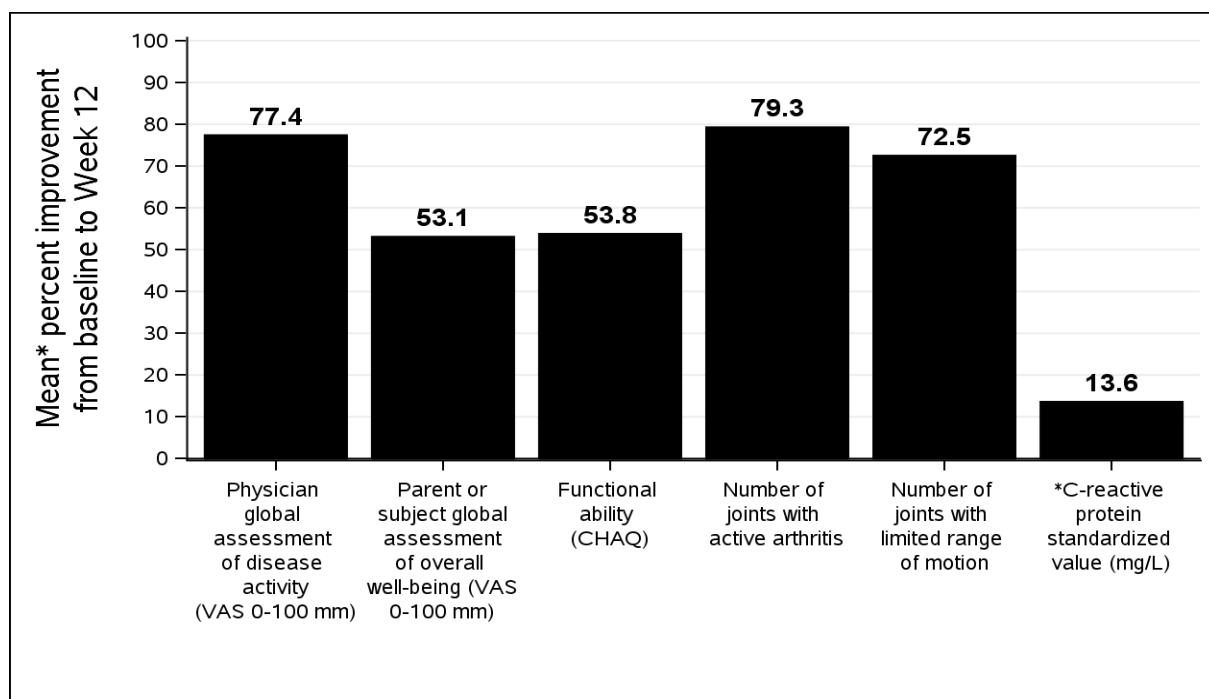

*C-reactive protein is shown as median percent improvement from baseline, due to outliers of C-reactive protein values

The study met its primary endpoint by demonstrating a statistically significant prolongation in the time to disease flare in patients treated with secukinumab compared to placebo. The risk of flare was reduced by 72% for patients on secukinumab compared with patients on placebo (Hazard Ratio of flare events=0.28, 95% CI: 0.13 to 0.63, p<0.001) (Figure 9). During Part 2, a total of 21 patients in the placebo group experienced a flare event (11 JPsA and 10 ERA) compared with 10 patients in the secukinumab group (4 JPsA and 6 ERA). Each component of the JIA ACR core components remained stable or improved for patients that continued on secukinumab.

Figure 9 Kaplan-Meier estimates of the time to disease flare in Part 2

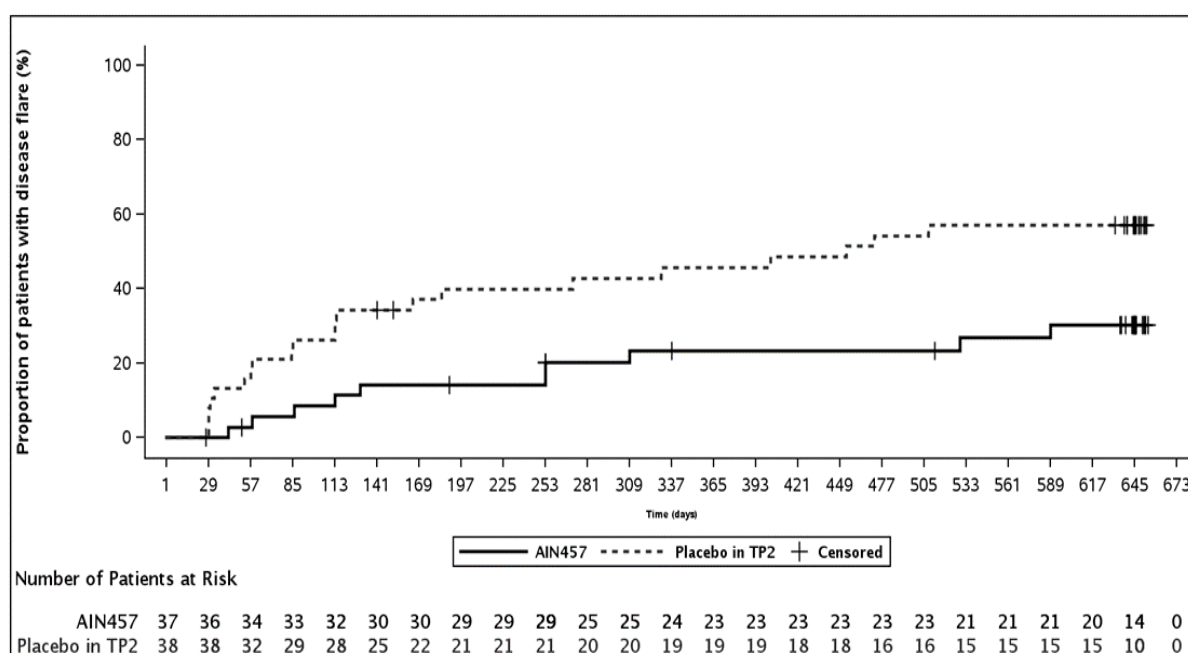

Hidradenitis Suppurativa

The safety and efficacy of secukinumab were assessed in 1,084 patients in two randomized, double-blind, placebo-controlled phase III studies in adult patients with moderate to severe hidradenitis suppurativa (HS) who were candidates for systemic biologic therapy. Patients enrolled in HS study 1 (SUNSHINE) and HS study 2 (SUNRISE) had Hurley stage I (4.6% and 2.8%, respectively), II (61.4% and 56.7%, respectively) or III (34.0% and 40.5%, respectively) disease at baseline with at least five inflammatory lesions affecting two anatomical areas. The proportion of patients weighing ≥ 90 kg was 54.7% in HS study 1 and 50.8% in HS study 2. Patients in these studies had a diagnosis of moderate to severe HS for a mean of 7.3 years and 56.3% of the study participants were female.

In HS study 1 and HS study 2, 23.8% and 23.2% of patients, respectively, were previously treated with a biologic and discontinued the biologic agent for either lack of efficacy or intolerance (bio-exposed patients).

HS study 1 evaluated 541 patients and HS study 2 evaluated 543 patients, of whom 12.8% and 10.7%, respectively, received concomitant stable dose of antibiotics. In both studies, patients randomized to secukinumab received 300 mg subcutaneously at Weeks 0, 1, 2, 3 and 4, followed by 300 mg every 2 weeks (Q2W) or every 4 weeks (Q4W). At Week 16, patients who were randomized to placebo were reassigned to receive secukinumab 300 mg at Weeks 16, 17, 18, 19 and 20 followed by either secukinumab 300 mg Q2W or secukinumab 300 mg Q4W.

The primary endpoint in both studies (HS study 1 and HS study 2) was the proportion of patients achieving a Hidradenitis Suppurativa Clinical Response defined as at least a 50% decrease in abscesses and inflammatory nodules count with no increase in the number of abscesses and/or in the number of draining fistulae relative to baseline (HiSCR50) at Week 16. Reduction in HS-related skin pain was assessed as a secondary endpoint on the pooled data of HS study 1 and HS study 2 using a Numerical Rating Scale (NRS) in patients who entered the studies with an initial baseline score of 3 or greater.

In HS study 1 and HS study 2, a significantly higher proportion of patients treated with secukinumab 300 mg Q2W achieved a HiSCR50 response with a significant decrease in abscesses and inflammatory nodules (AN) count compared to placebo at Week 16. In HS study 1, a significantly lower rate of patients experienced flares up to Week 16 with secukinumab 300 mg Q2W. A significantly higher proportion of patients treated with secukinumab 300 mg Q2W (pooled data) experienced a clinically relevant decrease in HS-related skin pain compared to placebo at Week 16.

Table 19 Clinical response in HS study 1 and HS study 2 at Week 16¹

	HS study 1			HS study 2		
	Placebo	300 mg Q4W	300 mg Q2W	Placebo	300 mg Q4W	300 mg Q2W
Number of patients randomized	180	180	181	183	180	180
HiSCR50, %	33.7	41.8	45.0*	31.2	46.1*	42.3*
AN count, LS mean change from baseline	-24.3	-42.4	-46.8*	-22.4	-45.5*	-39.3*
Flares, %	29.0	23.2	15.4*	27.0	15.6*	20.1
	Pooled data (HS study 1 and HS study 2)					
	Placebo		300 mg Q4W		300 mg Q2W	
Number of patients with NRS ≥3 at baseline	251		252		266	

NRS30 response, %	23.0	33.5	36.6*
¹ Multiple imputation was implemented for missing data * Statistically significant versus placebo based on the pre-defined hierarchy with overall alpha = 0.05 AN: Abscesses and inflammatory Nodules; HiSCR: Hidradenitis Suppurativa Clinical Response; NRS: Numerical Rating Scale			

In both studies, the onset of action of secukinumab occurred as early as Week 2, the efficacy progressively increased to Week 16 and was maintained up to Week 52.

Improvements were seen for the primary and key secondary endpoints in HS patients regardless of previous or concomitant antibiotic treatment.

HiSCR50 responses were improved at Week 16 in both biologic-naïve and biologic-exposed patients (pooled data; biologic-naïve: 45.6% and 45.4% for 300 mg Q2W and 300 mg Q4W, respectively, compared to placebo 34.2%; biologic-exposed: 37.0% and 38.8% for 300 mg Q2W and 300 mg Q4W, respectively, compared to placebo 27.3%).

Greater improvements at Week 16 from baseline compared to placebo were demonstrated in health-related quality of life as measured by the Dermatology Life Quality Index (DLQI response; HS study 1: 47.8% and 48.4% for 300 mg Q2W and 300 mg Q4W, respectively, compared to placebo 28.9%; HS study 2: 37.5% and 47.2% for 300 mg Q2W and 300 mg Q4W, respectively, compared to placebo 31.7%) and the Euro-QoL 5-Dimension 3-Level Health Status Questionnaire (EQ-5D-3L mean absolute change from baseline; HS study 1: 4.5 and 2.8 for 300 mg Q2W and 300 mg Q4W, respectively, compared to placebo 0.8; HS study 2: 9.9 and 3.3 for 300 mg Q2W and 300 mg Q4W, respectively, compared to placebo 0.3). Greater improvements at Week 16 from baseline compared to placebo were also demonstrated in Patient Global Impression of change and Patient Global Impression of severity.

NON-CLINICAL SAFETY DATA

Non-clinical data revealed no special hazard for humans based on tissue cross-reactivity testing, safety pharmacology, repeated dose and reproductive toxicity studies performed with secukinumab or a murine anti-murine IL-17A antibody.

Since secukinumab binds to cynomolgus monkey and human IL-17A, its safety was studied in the cynomolgus monkey. No undesirable effects of secukinumab were seen following subcutaneous administration to cynomolgus monkeys for up to 13 weeks and intravenous administration up to 26 weeks (including pharmacokinetic, pharmacodynamic, immunogenicity and immunotoxicity (e.g., T cell dependent antibody response and NK cell activity) evaluations). The average serum concentrations observed in monkeys after 13 weekly subcutaneous doses of 150 mg/kg are 48-fold higher than the predicted average serum

concentration expected in psoriatic patients at the highest clinical dose. The exposure multiples are even higher when the average serum concentration from the 26 weeks intravenous toxicology study in cynomolgus monkeys are taken into consideration. Antibodies to secukinumab were detected in only one out of 101 animals. No non-specific tissue cross-reactivity was demonstrated when secukinumab was applied to normal human tissues.

Animal studies have not been conducted to evaluate the carcinogenic potential of secukinumab.

For information on reproductive toxicity, see section PREGNANCY, LACTATION, FEMALES AND MALES OF REPRODUCTIVE POTENTIAL.

PHARMACEUTICAL INFORMATION

Incompatibilities

Solution for injection in pre-filled syringe and pre-filled pen: These medicinal products must not be mixed with other medicinal products.

Special precautions for storage

See folding box.

Store in a refrigerator at 2°C to 8°C.

For the pre-filled syringe and pre-filled pen only:

- Do not freeze.
- If necessary, may be stored unrefrigerated for a single period of up to 4 days at room temperature, not above 30°C.

Store in the original carton to protect from light.

Cosentyx should not be used after the date marked “EXP” on the pack.

Cosentyx must be kept out of the reach and sight of children.

Instructions for use and handling

Instructions for use of the Cosentyx 300 mg pre-filled syringe

Read ALL the way through these instructions before injecting. It is important not to try to inject yourself until you have been trained by your doctor, nurse or pharmacist. The box contains one Cosentyx 300 mg pre-filled syringe sealed in a plastic blister

Your Cosentyx 300 mg pre-filled syringe

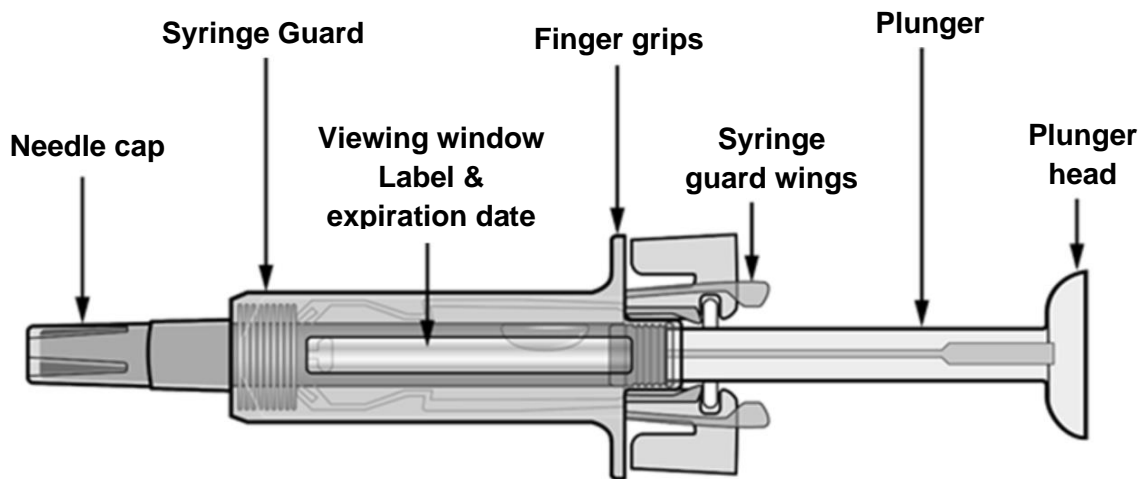

After the medication has been injected the syringe guard will be activated to cover the needle. This Cosentyx pre-filled syringe is intended to aid in the protection of healthcare professionals, patients who self-inject doctor-prescribed medications, and individuals who assist self-injecting patients from accidental needle sticks.

What you additionally need for your injection:

- Alcohol swab
- Cotton ball or gauze
- Sharps disposal container

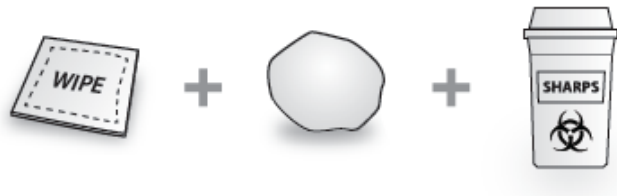

Important safety information

Caution: Keep the Cosentyx 300mg pre-filled syringe out of the reach of children.

1. Do not open the sealed outer box until you are ready to use the Cosentyx pre-filled syringe.
2. Do not use the Cosentyx pre-filled syringe if either the seal on the outer box or the seal of the blister are broken, as it may not be safe for you to use.
3. Do not use if the syringe has been dropped onto a hard surface or dropped after removing the needle cap.
4. Never leave the Cosentyx pre-filled syringe lying around where others might tamper with it.
5. Do not shake the Cosentyx pre-filled syringe.
6. Be careful not to touch the syringe guard wings before use. By touching them, the syringe guard may be activated too early.
7. Do not remove the needle cap until just before you give the injection.
8. The Cosentyx pre-filled syringe cannot be re-used. Dispose of the used Cosentyx pre-filled syringe immediately after use in a sharps container.

Storage of the Cosentyx 300 mg pre-filled syringe

1. Store the Cosentyx pre-filled syringe sealed in its outer box to protect it from light. Store in the refrigerator between 2°C and 8°C. **DO NOT FREEZE.**
2. Remember to take the Cosentyx pre-filled syringe out of the refrigerator and allow it to reach room temperature before preparing it for injection (30 to 45 minutes).
3. Do not use the Cosentyx pre-filled syringe after the expiration date shown on the outer box or syringe label. If it has expired, return the entire pack to the pharmacy.

The injection site

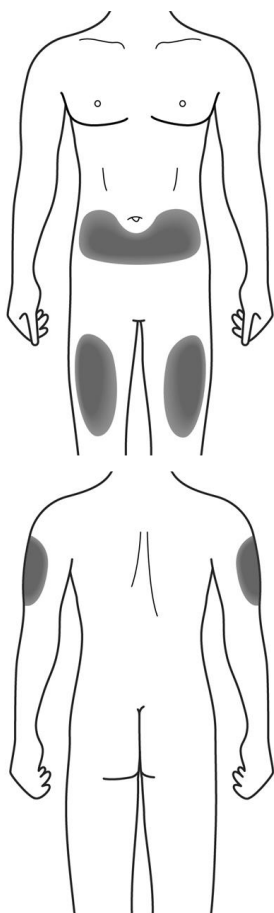

The injection site is the place on the body where you are going to use the Cosentyx pre-filled syringe.

- The recommended site is the front of your thighs. You may also use the lower abdomen, but **not** the area 2 inches (5 cm) around the navel (belly button). If a caregiver is giving you the injection, the outer upper arms may also be used.
- Choose a different site each time you give yourself an injection.
- Do not inject into areas where the skin is tender, bruised, red, scaly or hard. Avoid areas with scars or stretch marks.

Preparing the Cosentyx 300 mg pre-filled syringe ready for use

1. Take the box containing the Cosentyx pre-filled syringe out of the refrigerator and leave it **unopened** for about 30 to 45 minutes so that it reaches room temperature.
2. When you are ready to use the Cosentyx pre-filled syringe, wash your hands thoroughly with soap and water.
3. Clean the injection site with an alcohol swab.
4. Remove the Cosentyx pre-filled syringe from the outer box and take it out of the blister by holding the syringe guard body.
5. Inspect the Cosentyx pre-filled syringe. The liquid should be clear. Its color may vary from colorless to slightly yellow. You may see a small air bubble, which is normal. **DO NOT USE** if the liquid contains easily visible particles, is cloudy or is distinctly brown. **DO NOT USE** if the Cosentyx pre-filled syringe is broken. In all these cases, return the entire product pack to the pharmacy.

How to use the Cosentyx 300 mg pre-filled syringe

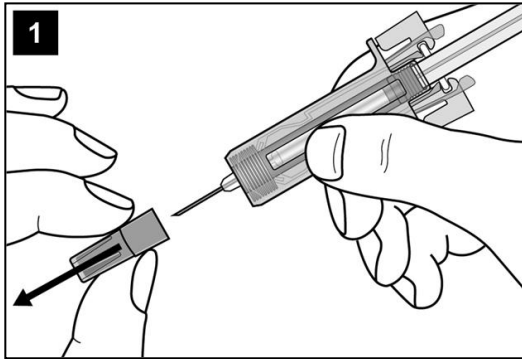

Carefully remove the needle cap from the Cosentyx pre-filled syringe. Discard the needle cap. You may see a drop of liquid at the end of the needle. This is normal.

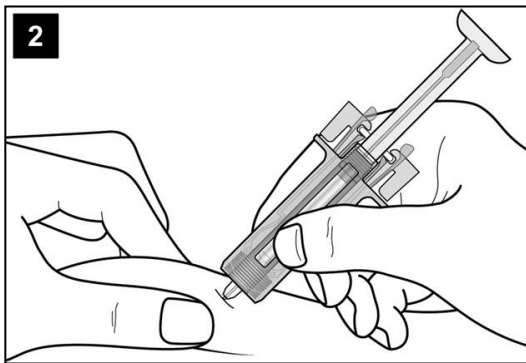

Gently pinch the skin at the injection site and insert the needle as shown. Push the needle all the way in to ensure that the medication can be fully administered.

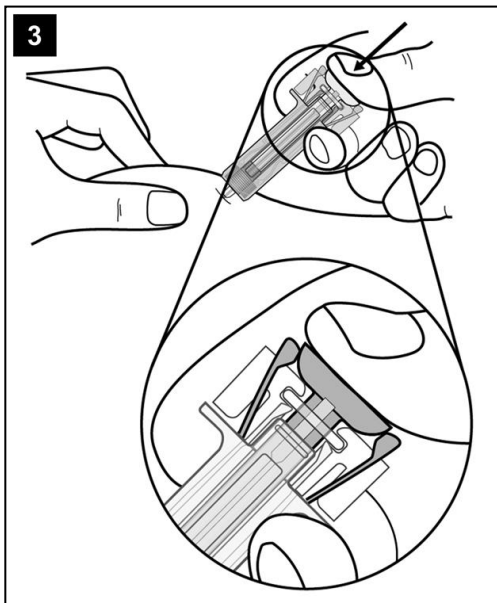

Holding the Cosentyx pre-filled syringe as shown, **slowly** depress the plunger **as far as it will go** so that the plunger head is completely between the syringe guard wings.

Keep the plunger pressed fully down while you hold the syringe in place for 5 seconds.

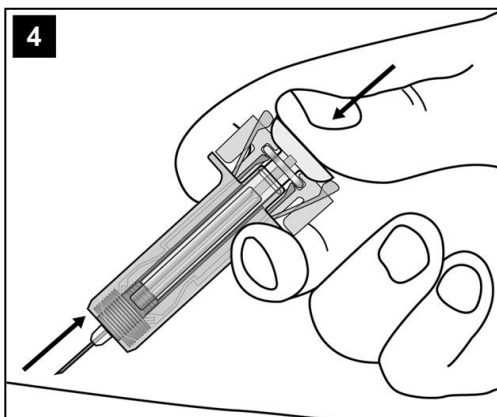

Keep the plunger fully depressed while you carefully lift the needle straight out from the injection site.

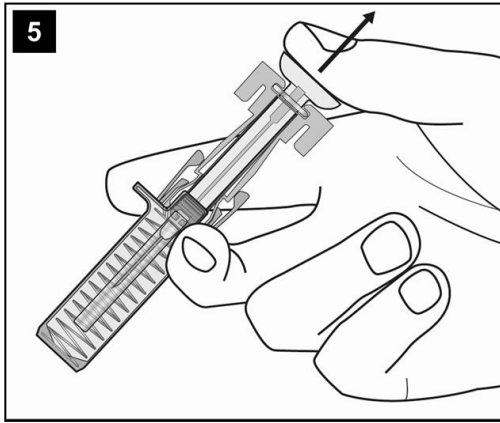

Slowly release the plunger and allow the syringe guard to automatically cover the exposed needle.

There may be a small amount of blood at the injection site. You can press a cotton ball or gauze over the injection site and hold it for 10 seconds. Do not rub the injection site. You may cover the injection site with a small adhesive bandage, if needed.

Disposal instructions



Dispose of the used Cosentyx pre-filled syringe in a sharps container (closable, puncture resistant container). For the safety and health of you and others, needles and used syringes **must never** be re-used.

Instructions for use of the Cosentyx 150 mg pre-filled syringe

Read ALL the way through these instructions before injecting. It is important not to try to inject yourself until you or a person in your care have been trained by your doctor, nurse or pharmacist. The box contains Cosentyx pre-filled syringe(s) individually sealed in a plastic blister.

Your Cosentyx pre-filled syringe

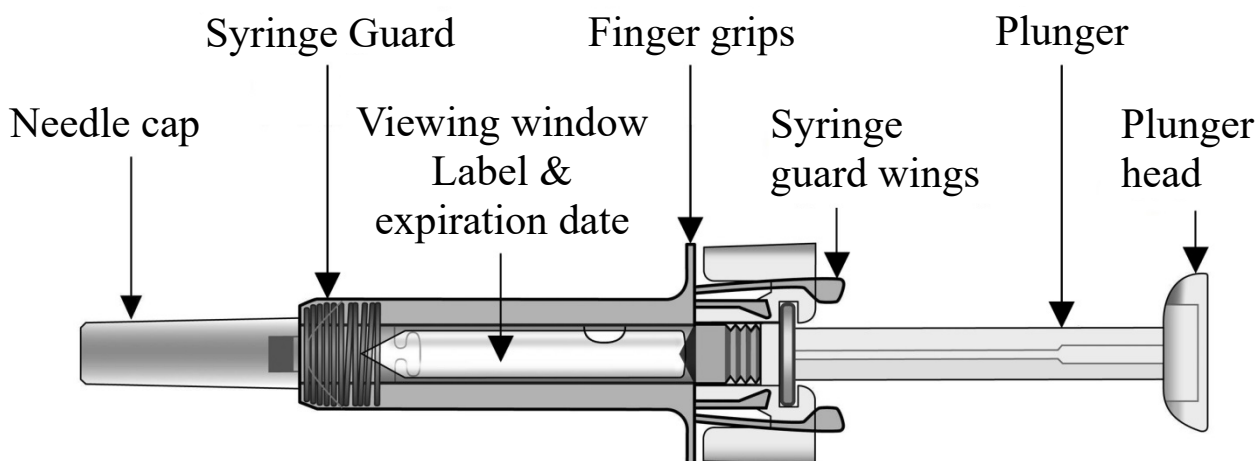

After the medication has been injected the syringe guard will be activated to cover the needle. This Cosentyx pre-filled syringe is intended to aid in the protection of healthcare professionals, patients who self-inject doctor prescribed medications and individuals that assist self-injecting patients from accidental needle sticks.

What you additionally need for your injection:

- Alcohol swab.
- Cotton ball or gauze.
- Sharps disposal container.



Important safety information

Caution: Keep the Cosentyx pre-filled syringe out of the reach of children.

1. The needle cap of the syringe may contain dry rubber (latex), which should not be handled by persons sensitive to this substance.
2. Do not open the sealed outer box until you are ready to use the Cosentyx pre-filled syringe.
3. Do not use the Cosentyx pre-filled syringe if either the seal on the outer box or the seal of the blister are broken, as it may not be safe for you to use.
4. Do not use if the syringe has been dropped onto a hard surface or dropped after removing the needle cap.
5. Never leave the Cosentyx pre-filled syringe lying around where others might tamper with it.
6. Do not shake the Cosentyx pre-filled syringe.

7. Be careful not to touch the syringe guard wings before use. By touching them, the syringe guard may be activated too early.
8. Do not remove the needle cap until just before you give the injection.
9. The Cosentyx pre-filled syringe cannot be re-used. Dispose of the used Cosentyx pre-filled syringe immediately after use in a sharps container.

Storage of the Cosentyx 150 mg pre-filled syringe

1. Store the Cosentyx pre-filled syringe sealed in its outer box to protect it from light. Store in the refrigerator between 2°C and 8°C. **DO NOT FREEZE.**
2. Remember to take the Cosentyx pre-filled syringe out of the refrigerator and allow it to reach room temperature before preparing it for injection (15 to 30 minutes).
3. Do not use the Cosentyx pre-filled syringe after the expiration date shown on the outer box or syringe label. If it has expired, return the entire pack to the pharmacy.

The injection site

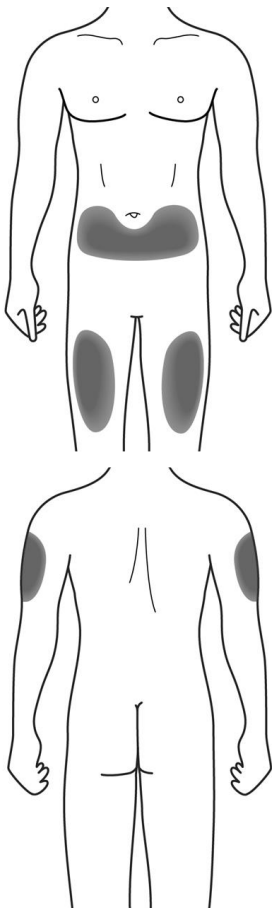

The injection site is the place on the body where you are going to use the Cosentyx pre-filled syringe.

- The recommended site is the front of your thighs. You may also use the lower abdomen, but **not** the area 2 inches (5 cm) around the navel (belly button). If a caregiver is giving you the injection, the outer upper arms may also be used.
- Choose a different site each time you give yourself an injection.
- Do not inject into areas where the skin is tender, bruised, red, scaly or hard. Avoid areas with scars or stretch marks.

Preparing the Cosentyx 150 mg pre-filled syringe ready for use

Note: For a 150 mg dose, prepare 1 pre-filled syringe and inject the content. For a 300 mg dose, prepare 2 pre-filled syringes and inject the content of both.

1. Take the box containing the Cosentyx pre-filled syringe out of the refrigerator and leave it **unopened** for about 15 to 30 minutes so that it reaches room temperature.
2. When you are ready to use the Cosentyx pre-filled syringe, wash your hands thoroughly with soap and water.

3. Clean the injection site with an alcohol swab.
4. Remove the Cosentyx pre-filled syringe from the outer box and take it out of the blister.
5. Inspect the Cosentyx pre-filled syringe. The liquid should be clear. Its color may vary from colorless to slightly yellow. You may see a small air bubble, which is normal. **DO NOT USE** if the liquid contains easily visible particles, is cloudy or is distinctly brown. **DO NOT USE** if the Cosentyx pre-filled syringe is broken. In all these cases, return the entire product pack to the pharmacy.

How to use the Cosentyx 150mg pre-filled syringe

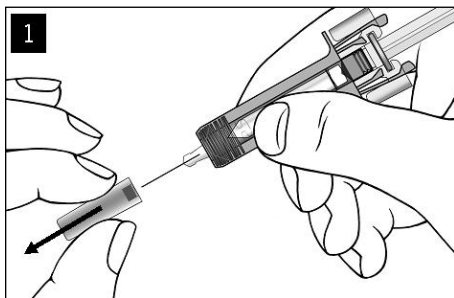

Carefully remove the needle cap from the Cosentyx pre-filled syringe. Discard the needle cap. You may see a drop of liquid at the end of the needle. This is normal.

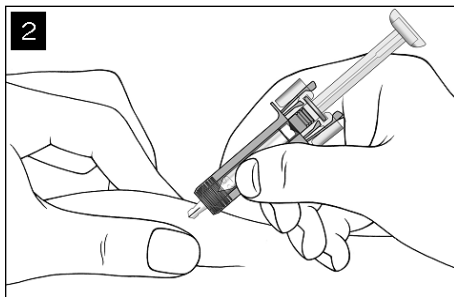

Gently pinch the skin at the injection site and insert the needle as shown. Push the needle all the way in to ensure that the medication can be fully administered.

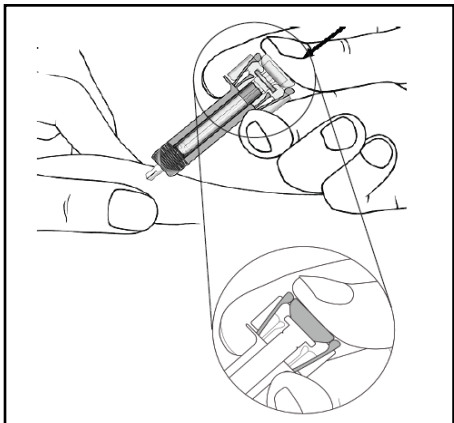

Holding the Cosentyx pre-filled syringe as shown, **slowly** depress the plunger **as far as it will go** so that the plunger head is completely between the syringe guard wings.

Keep the plunger pressed fully down while you hold the syringe in place for 5 seconds.

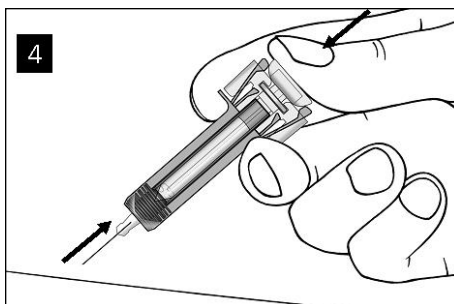

Keep the plunger fully depressed while you carefully lift the needle straight out from the injection site.

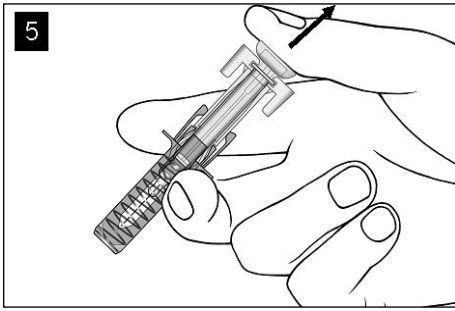

Slowly release the plunger and allow the syringe guard to automatically cover the exposed needle.

There may be a small amount of blood at the injection site. You can press a cotton ball or gauze over the injection site and hold it for 10 seconds. Do not rub the injection site. You may cover the injection site with a small adhesive bandage, if needed.

Disposal instructions

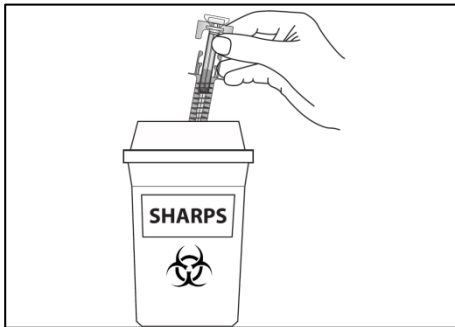

Dispose of the used Cosentyx pre-filled syringe in a sharps container (closable, puncture resistant container). For the safety and health of you and others, needles and used syringes **must never** be re-used.

Instructions for use of the 75 mg Cosentyx pre-filled syringe

Read ALL the way through these instructions before injecting. It is important not to try to inject yourself until you or a person in your care have been trained by your doctor, nurse or pharmacist. The box contains one Cosentyx 75 mg pre-filled syringe individually sealed in a plastic blister.

Your Cosentyx 75 mg pre-filled syringe

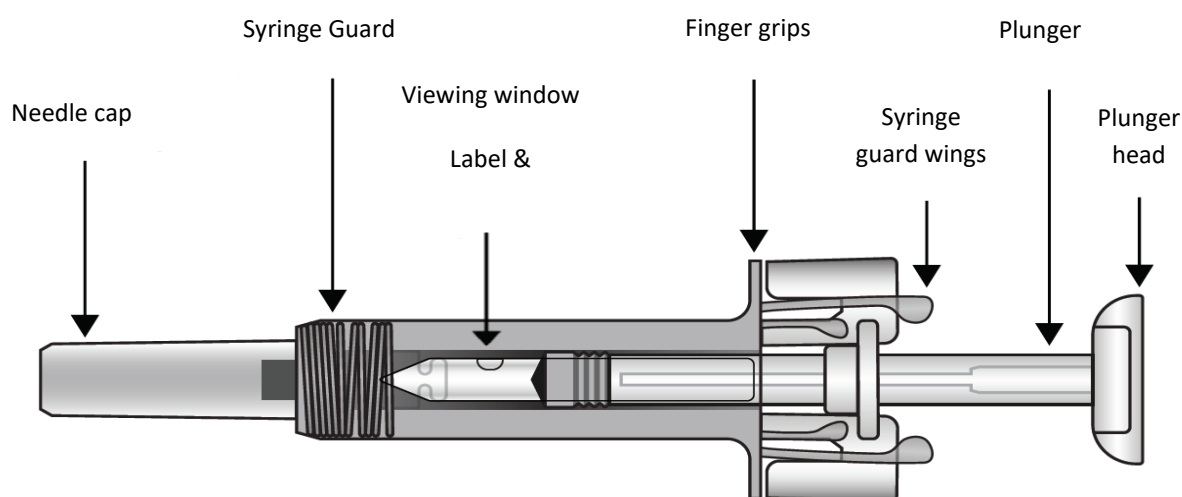

After the medication has been injected the syringe guard will be activated to cover the needle. This Cosentyx pre-filled syringe is intended to aid in the protection of healthcare professionals, patients who self-inject doctor-prescribed medications, and individuals who assist self-injecting patients from accidental needle sticks.

What you additionally need for your injection:

- Alcohol swab.
- Cotton ball or gauze.
- Sharps disposal container.



Important safety information

Caution: Keep the Cosentyx pre-filled syringe out of the reach of children.

1. The needle cap of the syringe contains dry rubber (latex), which should not be handled by persons sensitive to this substance.
2. Do not open the sealed outer box until you are ready to use the Cosentyx pre-filled syringe.
3. Do not use the Cosentyx pre-filled syringe if either the seal on the outer box or the seal of the blister are broken, as it may not be safe for you to use.
4. Do not use if the syringe has been dropped onto a hard surface or dropped after removing the needle cap.
5. Never leave the Cosentyx pre-filled syringe lying around where others might tamper with it.

6. Do not shake the Cosentyx pre-filled syringe.
7. Be careful not to touch the syringe guard wings before use. By touching them, the syringe guard may be activated too early.
8. Do not remove the needle cap until just before you give the injection.
9. The Cosentyx pre-filled syringe cannot be re-used. Dispose of the used Cosentyx pre-filled syringe immediately after use in a sharps container.

Storage of the Cosentyx 75 mg pre-filled syringe

1. Store the Cosentyx pre-filled syringe sealed in its outer box to protect it from light. Store in the refrigerator between 2°C and 8°C. **DO NOT FREEZE.**
2. Do not use the Cosentyx pre-filled syringe after the expiration date shown on the outer box or syringe label. If it has expired, return the entire pack to the pharmacy.

The injection site

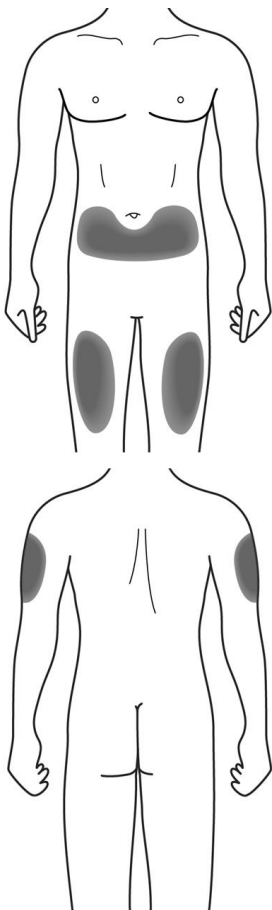

The injection site is the place on the body where you are going to use the Cosentyx pre-filled syringe.

- The recommended site is the front of your thighs. You may also use the lower abdomen, but **not** the area 2 inches (5 cm) around the navel (belly button). If a caregiver is giving you the injection, the outer upper arms may also be used.
- Choose a different site each time you give yourself an injection.
- Do not inject into areas where the skin is tender, bruised, red, scaly or hard. Avoid areas with scars or stretch marks.

Preparing the Cosentyx 75 mg pre-filled syringe ready for use

1. Take the box containing the Cosentyx pre-filled syringe out of the refrigerator and leave it **unopened** for about 15 to 30 minutes so that it reaches room temperature.
2. When you are ready to use the Cosentyx pre-filled syringe, wash your hands thoroughly with soap and water.
3. Clean the injection site with an alcohol swab.
4. Remove the Cosentyx pre-filled syringe from the outer box and take it out of the blister.
5. Inspect the Cosentyx pre-filled syringe. The liquid should be clear. Its color may vary from colorless to slightly yellow. You may see a small air bubble, which is normal. **DO NOT**

USE if the liquid contains easily visible particles, is cloudy or is distinctly brown. DO NOT USE if the Cosentyx pre-filled syringe is broken. In all these cases, return the entire product pack to the pharmacy.

6. How to use the Cosentyx 75 mg pre-filled syringe

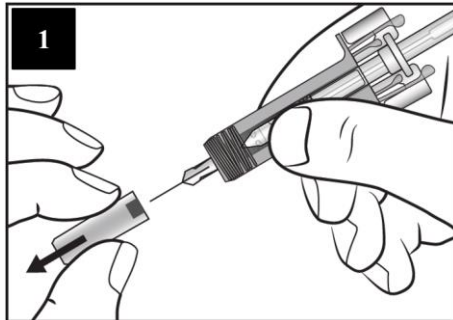

Carefully remove the needle cap from the Cosentyx pre-filled syringe. Discard the needle cap. You may see a drop of liquid at the end of the needle. This is normal.

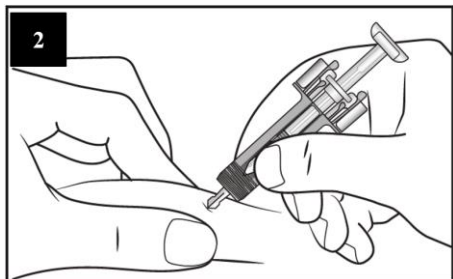

Gently pinch the skin at the injection site and insert the needle as shown. Push the needle all the way in to ensure that the medication can be fully administered.

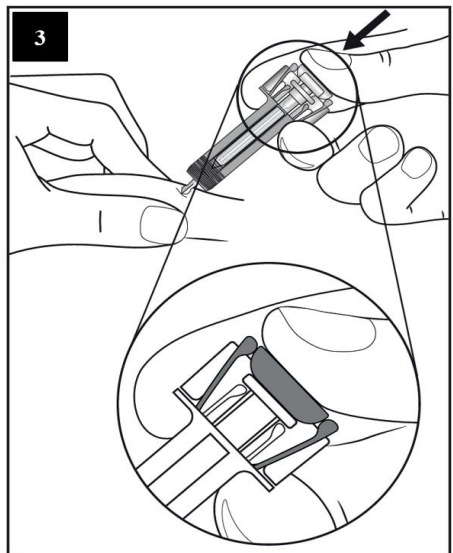

Holding the Cosentyx pre-filled syringe as shown, **slowly** depress the plunger **as far as it will go** so that the plunger head is completely between the syringe guard wings.

Keep the plunger pressed fully down while you hold the syringe in place for 5 seconds.

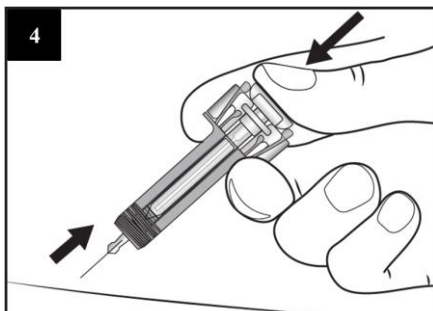

Keep the plunger fully depressed while you carefully lift the needle straight out from the injection site.

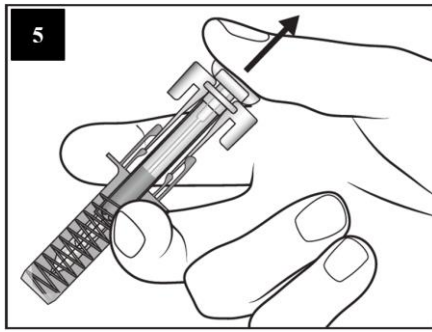

Slowly release the plunger and allow the syringe guard to automatically cover the exposed needle.

There may be a small amount of blood at the injection site. You can press a cotton ball or gauze over the injection site and hold it for 10 seconds. Do not rub the injection site. You may cover the injection site with a small adhesive bandage, if needed.

Disposal instructions

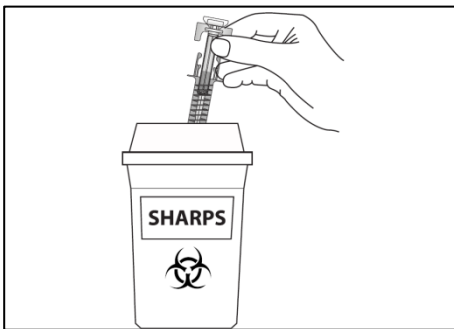

Dispose of the used Cosentyx pre-filled syringe in a sharps container (closable, puncture resistant container). For the safety and health of you and others, needles and used syringes **must never** be re-used.

INSTRUCTIONS FOR USE OF COSENTYX 300 MG UNOREADY SOLUTION FOR INJECTION IN PRE-FILLED PEN



Cosentyx UNOREADY pen 300 mg

Solution for injection in a pre-filled pen

Single-use pen for subcutaneous injection

Secukinumab

Patient Instructions for Use



Read ALL the way through these instructions before injecting.

These instructions are to help you to inject correctly using the Cosentyx UNOREADY pen.

It is important not to try to inject yourself until you have been trained by your doctor, nurse or pharmacist.

Your Cosentyx UNOREADY pen 300 mg:

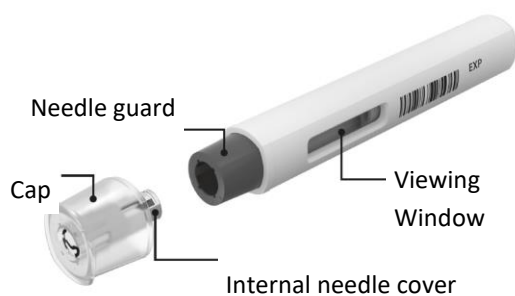

Cosentyx UNOREADY pen is shown above with the cap removed. **Do not** remove the cap until you are ready to inject.

Do not use the Cosentyx UNOREADY pen if the seal on the outer carton is broken.

Keep the Cosentyx UNOREADY pen in the sealed outer carton until you are ready to use it to protect it from light.

Store your Cosentyx UNOREADY pen in a **refrigerator** between 2°C and 8°C and **out of the reach of children**.

Do not **freeze** the Cosentyx UNOREADY pen.

Do not **shake** the Cosentyx UNOREADY pen.

Do not use the Cosentyx UNOREADY pen if it has been **dropped** with the cap removed.

The needle is covered by the needle guard and the needle will not be seen. **Do not** touch or push the needle guard because you could get a needle stick.

What you need for your injection



What you need for your injection:

Included in the carton:

- A new, unused Cosentyx UNOREADY pen

Not included in the carton:

- Alcohol swab
- Cotton ball or gauze
- Sharps disposal container

See “**How should I dispose of used Cosentyx UNOREADY pens?**” at the end of this Instructions for Use.

Before your injection:

For a more comfortable injection, take the Cosentyx UNOREADY pen out of the refrigerator **30 to 45 minutes before injecting** to allow it to reach room temperature.

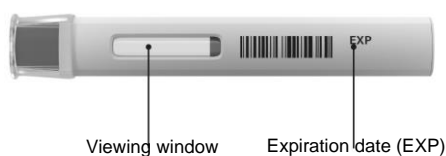

1. Important safety checks before you inject:

For the “viewing window”:

The liquid should be clear. Its color may vary from colorless to slightly yellow.

Do not use if the liquid contains visible particles, is cloudy or is distinctly brown. You may see air bubbles, which is normal.

For the “Expiration date”:

Look at the expiration date (EXP) on your Cosentyx pen. **Do not use** the pen if the **expiration date** has passed.

Check that your pen contains the correct medicine and dosage.

Contact your pharmacist if the pen fails any of these checks.

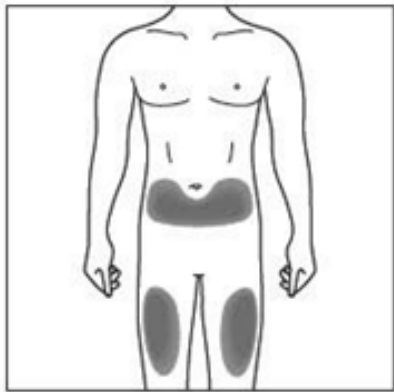

2a/ Choose your injection site:

- The recommended site is the front of the thighs. You may also use the lower abdomen, but **not** the area 2 inches (5 cm) around the navel (belly button).
- Choose a different site each time you give yourself an injection.
- Do not inject into areas where the skin is tender, bruised, red, scaly or hard. Avoid areas with scars or stretch marks.

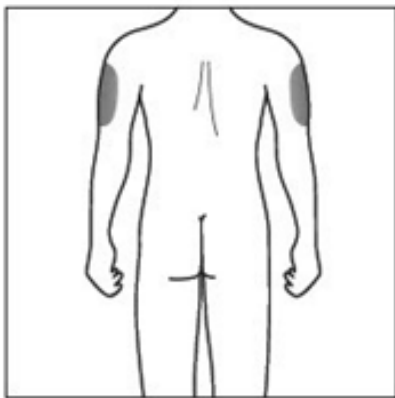

2b/ Caregivers and healthcare professionals only:

- If a **caregiver** or **healthcare professional** is giving you your injection, they may also inject into your outer upper arm.



3/ Cleaning your injection site:

- Wash your hands with soap and hot water.
- Using a circular motion, clean the injection site with the alcohol swab. Leave it to dry before injecting.
- Do not touch the cleaned area again before injecting.

Your injection:

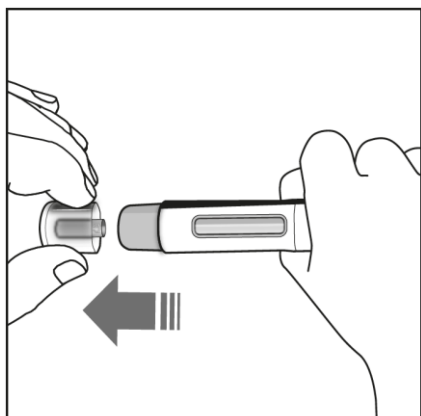

4/ Removing the cap:

- Only remove the cap when you are ready to use the pen.
- Pull the cap straight off in the direction of the arrow that is shown in the figure on left.
- Once removed, throw away the cap. **Do not try to re attach the cap** as you may bend the needle.
- Use the pen within 5 minutes of removing the cap.

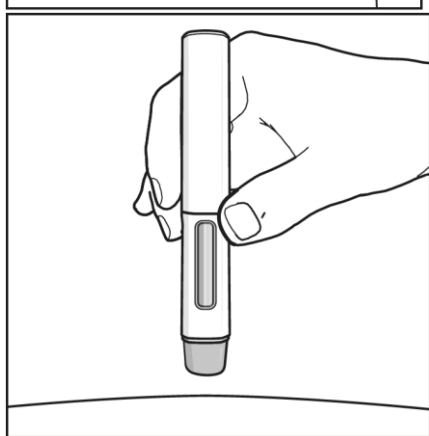

5/ Holding your Cosentyx UNOREADY pen:

- Hold the pen at 90 degrees to the cleaned injection site.

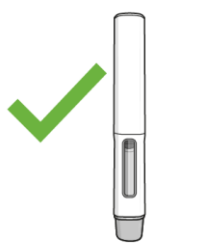

Correct

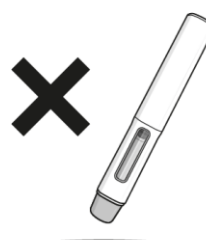

Incorrect



YOU MUST READ THIS BEFORE INJECTING.

During the injection you will hear 2 clicks.

The 1st click indicates that the injection has started. Several seconds later a 2nd click will indicate that the injection is almost finished.

You must keep holding the pen firmly against your skin until you see a green indicator with a grey tip fill the window and stop moving.

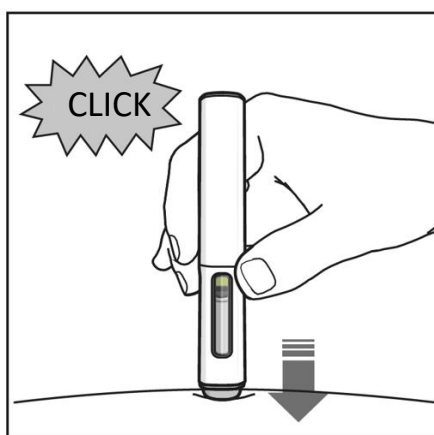

6/ Starting your injection:

- Press the pen firmly against the skin to start the injection.
- The **1st click** indicates the injection has started.
- **Keep holding** the pen firmly against your skin.
- The **green indicator with the grey tip** shows the progress of the injection.

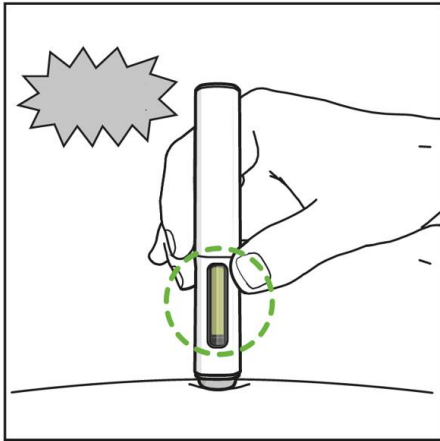

7/ Completing your injection:

- Listen for the **2nd click**. This indicates the injection is **almost** complete.
- Check the **green indicator with the grey tip** has filled the window and has stopped moving.
- The pen can now be removed

After your injection:

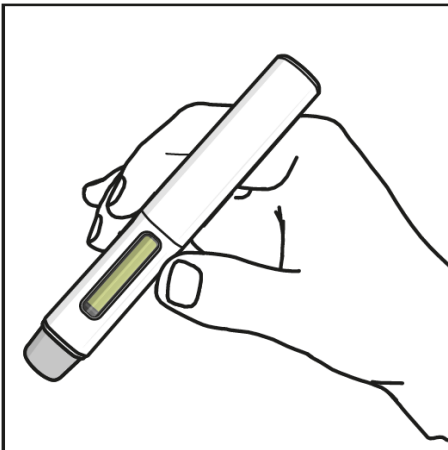

8/ Check the green indicator fills the window:

- This means the medicine has been delivered. Contact your doctor or pharmacist if the green indicator is not visible.
- There may be a small amount of blood at the injection site. You can press a cotton ball or gauze over the injection site and hold it for 10 seconds. Do not rub the injection site. You may cover the injection site with a small adhesive bandage, if needed.

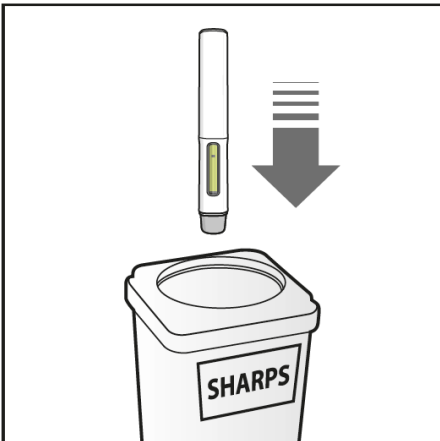

9/ Disposing of your Cosentyx UNOREADY pen:

- Dispose of the used pen in a sharps disposal container (i.e. a puncture-resistant closable container, or similar).
- Never try to reuse your pen.

Instructions for use of Cosentyx 150 mg SensoReady solution for injection in pre-filled pen



Cosentyx SensoReady pen 150 mg

Solution for injection in a pre-filled pen

Secukinumab

Patient Instructions for Use



Read ALL the way through these instructions before injecting.

These instructions are to help you to inject correctly using the Cosentyx SensoReady pen.

It is important not to try to inject yourself or a person in your care until you have been trained by your doctor, nurse or pharmacist.

Your Cosentyx SensoReady pen:

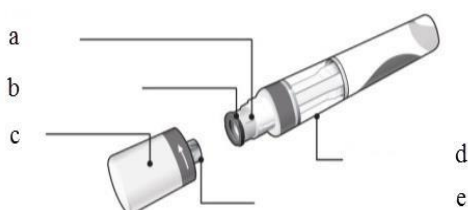

- a. Needle
- b. Needle guard
- c. Cap
- d. Inspection window
- e. Internal needle cover

Store your boxed Cosentyx SensoReady pen in a **refrigerator** between 2°C and 8°C and **out of the reach of children**.

- Do not **freeze** the Cosentyx SensoReady pen.
- Do not **shake** the Cosentyx SensoReady pen.
- Do not use the Cosentyx SensoReady pen if it has been **dropped** with the cap removed.

Cosentyx SensoReady pen shown with the cap removed. **Do not** remove the cap until you are ready to inject.

For a more comfortable injection, take the Cosentyx SensoReady pen out of the refrigerator **15 to 30 minutes before injecting** to allow it to reach room temperature.

What you need for your injection:

Included in the carton:

A new and unused Cosentyx SensoReady pen. 1 pen is needed for a 150 mg dose and 2 pens are needed for a 300 mg dose.

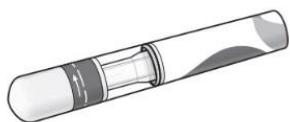

Not included in the carton:

- Alcohol swab.
- Cotton ball or gauze.
- Sharps disposal container.



Before your injection:

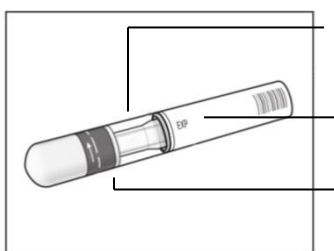

1/ Important safety checks before you inject:

- The liquid should be clear. Its color may vary from colorless to slightly yellow.
- **Do not use** if the liquid contains easily visible particles, is cloudy or is distinctly brown. You may see a small air bubble, which is normal.
- **Do not use** your Cosentyx SensoReady pen if the **expiration date** has passed.
- **Do not use** if the **safety seal** has been broken.

Contact your pharmacist if the Cosentyx SensoReady pen fails any of these checks.

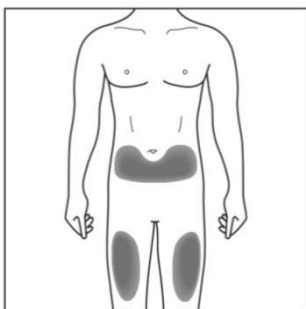

2a/ Choose your injection site:

- The recommended site is the front of the thighs. You may also use the lower abdomen, but not the area 2 inches around the navel (belly button).
- Choose a different site each time you give yourself an injection.
- Do not inject into areas where the skin is tender, bruised, red, scaly or hard. Avoid areas with scars or stretch marks.

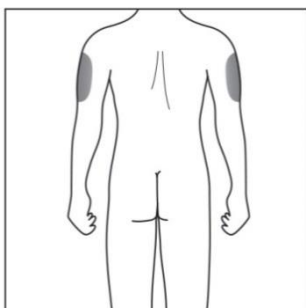

2b/ Caregivers and Healthcare Professionals Only:

- If a **caregiver** or **healthcare professional** is giving you your injection, they may also inject into your outer upper arm.



3/ Cleaning your injection site:

- Wash your hands with hot soapy water.
- Using a circular motion, clean the injection site with the alcohol swab. Leave it to dry before injecting.
- Do not touch the cleaned area again before injecting.

Your injection:

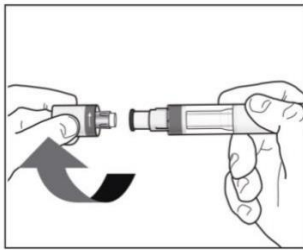

4/ Removing the cap:

- Only remove the cap when you are ready to use the Cosentyx SensoReady pen.
- Twist off the cap in the direction of the arrows.
- Once removed, throw away the cap. **Do not try to re-attach the cap.**
- Use the Cosentyx SensoReady pen within 5 minutes of removing the cap.

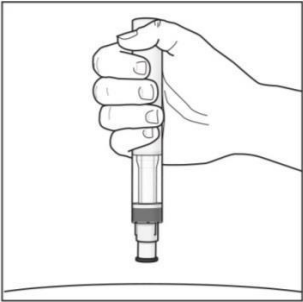

5/ Holding your Cosentyx SensoReady pen:

- Hold the Cosentyx SensoReady pen at 90 degrees to the cleaned injection site.

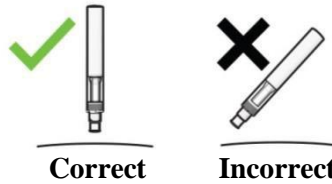

YOU MUST READ THIS BEFORE INJECTING.

During the injection you will hear **2 loud clicks**.

The **1st click** indicates that the injection has started. Several seconds later a **2nd click** will indicate that the injection is **almost** finished.

You must keep holding the Cosentyx SensoReady pen firmly against your skin until you see a **green indicator** fill the window and stop moving.

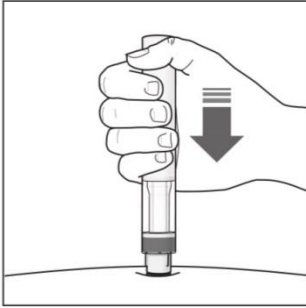

6/ Starting your injection:

- Press the Cosentyx SensoReady pen firmly against the skin to start the injection.
- The **1st click** indicates the injection has started.
- **Keep holding** the Cosentyx SensoReady pen firmly against your skin.
- The **green indicator** shows the progress of the injection.

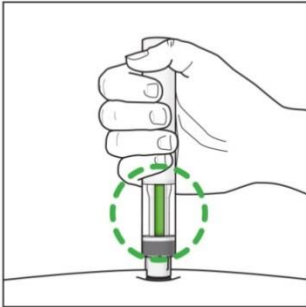

7/ Completing your injection:

- Listen for the **2nd click**. This indicates the injection is **almost** complete.
- Check the **green indicator** fills the window and has stopped moving.
- The Cosentyx SensoReady pen can now be removed.

After your injection:

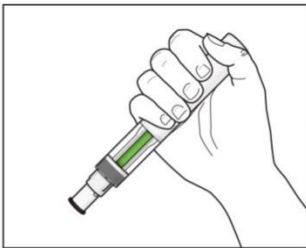

8/ Check the green indicator fills the window:

- This means the medicine has been delivered. Contact your doctor if the green indicator is not visible.
- There may be a small amount of blood at the injection site. You can press a cotton ball or gauze over the injection site and hold it for 10 seconds. Do not rub the injection site. You may cover the injection site with a small adhesive bandage, if needed.

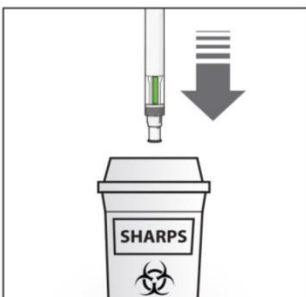

9/ Disposing of your Cosentyx SensoReady pen:

- Dispose of the used Cosentyx SensoReady pen in a sharps disposal container (i.e. a puncture-resistant closable container, or similar).
- Never try to reuse your Cosentyx SensoReady pen.

Manufacturer:

See folding box.

® = registered trademark

Novartis Pharma AG, Basel, Switzerland