

INSTRUCTIONS FOR USE

COSENTYX® [koe-sen-tix]

(secukinumab)

injection, for subcutaneous use

300 mg/2 mL single-dose prefilled syringe

Be sure that you read, understand, and follow this Instructions for Use before injecting COSENTYX. Your healthcare provider should show you how to prepare and inject COSENTYX properly using the prefilled syringe before you use it for the first time. Talk to your healthcare provider if you have any questions.

Important Information You Need to Know Before Injecting COSENTYX:

- **Do not use** the COSENTYX prefilled syringe if either the seal on the outside carton or the seal of the blister are broken. Keep the COSENTYX prefilled syringe in the sealed carton until you are ready to use it.
- **Do not use** the COSENTYX prefilled syringe if the syringe has been dropped onto a hard surface or dropped after removing the needle cap.
- **Do not shake** the COSENTYX prefilled syringe.
- The prefilled syringe has a needle guard that will be activated to cover the needle after the injection is finished. The needle guard will help to prevent needle stick injuries to anyone who handles the prefilled syringe.
- **Do not** remove the needle cap until just before you give the injection.
- Avoid touching the syringe guard wings before use. Touching them may cause the syringe guard to be activated too early.
- Throw away (dispose of) the used COSENTYX prefilled syringe right away after use. **Do not re-use the COSENTYX prefilled syringe.** See “How should I dispose of the used COSENTYX prefilled syringe?” at the end of this Instructions for Use.

How should I store COSENTYX?

- Store your carton of COSENTYX prefilled syringe in a refrigerator, between 36°F to 46°F (2°C to 8°C).
- Keep the COSENTYX prefilled syringe in the original carton until ready to use to protect from light.
- **Do not** freeze the COSENTYX prefilled syringe.
- Throw away (dispose of) any expired or unused COSENTYX prefilled syringes.

Keep COSENTYX and all medicines out of the reach of children.

COSENTYX prefilled syringe parts (see Figure A):

Figure A

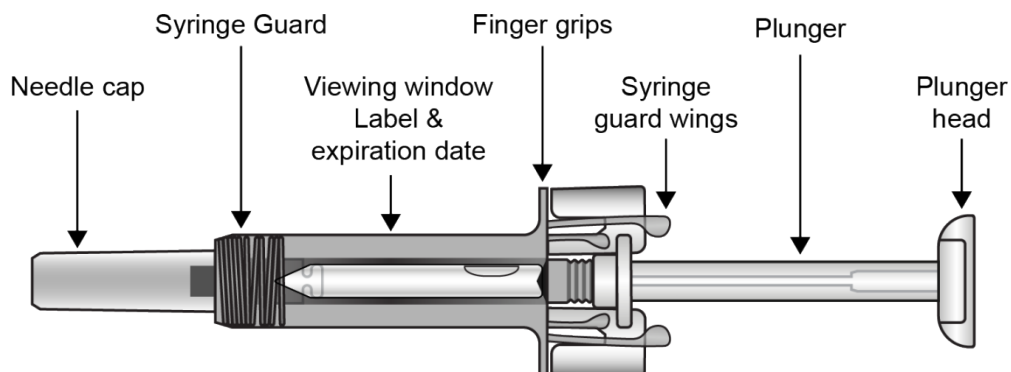

What you need for your injection:

Included in the carton:

A new COSENTYX prefilled syringe.

Each COSENTYX prefilled syringe contains **300 mg** of COSENTYX. Check to make sure that you have the correct medicine and dose.

Not included in the carton (**see Figure B**):

- 1 Alcohol wipe
- 1 Cotton ball or gauze
- Sharps disposal container

See “**How should I dispose of the used COSENTYX prefilled syringe?**” at the end of this Instructions for Use.

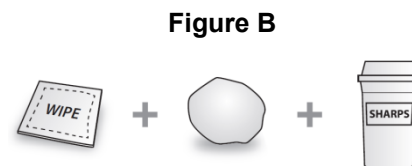

Prepare the COSENTYX 300 mg prefilled syringe

Step 1. Find a clean, well-lit, flat work surface.

Step 2. Take the carton containing the COSENTYX prefilled syringe out of the refrigerator and leave it **unopened** on your work surface for about 30 to 45 minutes so that it reaches room temperature.

Step 3. Wash your hands well with soap and water.

Step 4. Remove the COSENTYX prefilled syringe from the outer carton and take it out of the blister.

Step 5. Look through the viewing window on the COSENTYX prefilled syringe. The liquid inside should be clear. The color may be colorless to slightly yellow. You may see a small air bubble in the liquid. This is normal. **Do not use** the prefilled syringe if the liquid contains visible particles, or if the liquid is cloudy or discolored.

Step 6. Do not use the COSENTYX prefilled syringe if it is broken. Return the prefilled syringe and the package it came in to the pharmacy.

Step 7. Do not use the COSENTYX prefilled syringe if the expiration date has passed.

Choose and clean the injection site

- Areas of your body that you may use as injection sites include:
 - the front of your thighs (**see Figure C**)
 - the lower stomach-area (abdomen), but **not** the area 2 inches around your navel (belly button) (**see Figure C**)
 - the upper outer arms, if a caregiver or healthcare provider is giving you the injection (**see Figure D**)
- Choose a different site for each injection of COSENTYX.
- **Do not** inject into areas where the skin is tender, bruised, red, scaly, or hard, or in an area of skin that is affected by psoriasis. Avoid areas with scars or stretch marks.

Step 8. Using a circular motion, clean the injection site with the alcohol wipe. Leave it to dry before injecting. **Do not** touch the cleaned area again before injecting.

Figure C

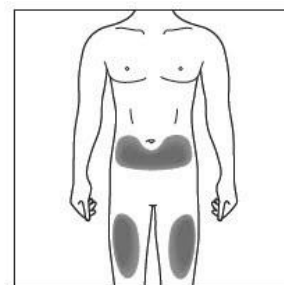
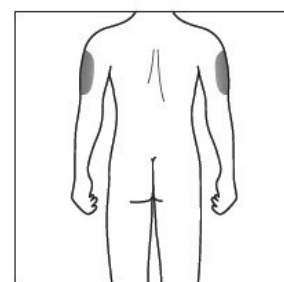

Figure D



Giving the injection

Step 9. Carefully remove the needle cap from the COSENTYX prefilled syringe (see **Figure E**). Throw away the needle cap. You may see a drop of liquid at the end of the needle. This is normal.

Figure E

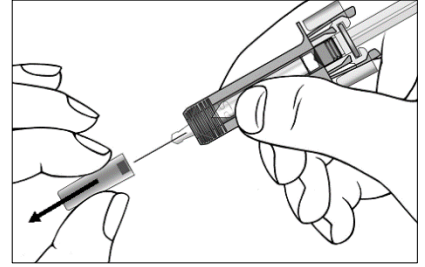

Step 10. With one hand gently pinch the skin at the injection site. With your other hand insert the needle into your skin at a 45-degree angle as shown (see **Figure F**). Push the needle all the way in to make sure that you inject your full dose.

Figure F

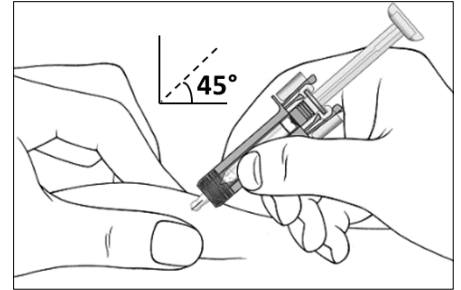

Step 11. Hold the COSENTYX prefilled syringe finger grips as shown (see **Figure G**). Slowly press down on the plunger as far as it will go, so that the plunger head is completely between the syringe guard wings. This will make sure that the syringe guard has been activated.

Figure G

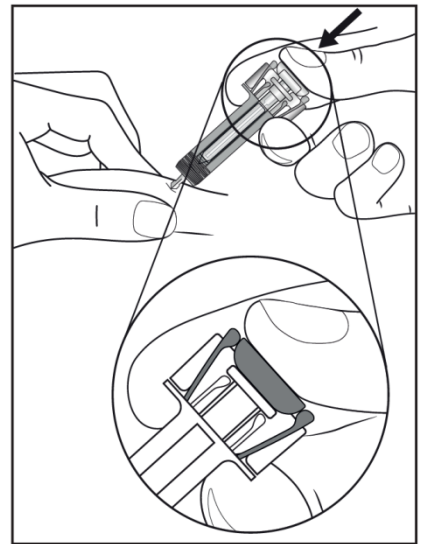

Step 12. Continue to press fully on the plunger for an additional 5 seconds. Hold the syringe in place for the full 5 seconds.

Figure H

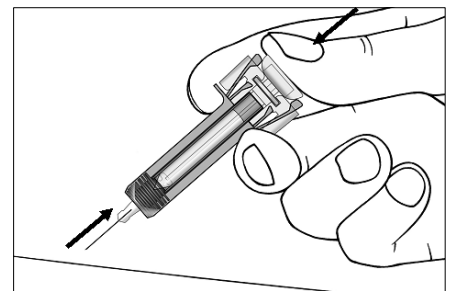

Step 13. Keep the plunger fully depressed while you carefully pull the needle straight out from the injection site (see **Figure H**).

Step 14. Slowly release the plunger and allow the syringe guard to automatically cover the exposed needle (**see Figure I**).

Step 15. There may be a small amount of blood at the injection site. You can press a cotton ball or gauze over the injection site and hold it for 10 seconds. **Do not** rub the injection site. You may cover the injection site with a small adhesive bandage, if needed.

Figure I

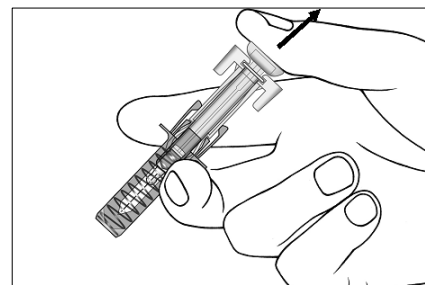

How should I dispose of the used COSENTYX prefilled syringe?

Step 16. Put your used prefilled syringe in an FDA-cleared sharps disposal container right away after use (**see Figure J**). **Do not throw away (dispose of)** the prefilled syringe in your household trash.

If you do not have an FDA-cleared sharps disposal container, you may use a household container that is:

- made of a heavy-duty plastic,
- can be closed with a tight-fitting, puncture-resistant lid, without sharps being able to come out,
- upright and stable during use,
- leak-resistant, and
- properly labeled to warn of hazardous waste inside the container.

When your sharps disposal container is almost full, you will need to follow your community guidelines for the right way to dispose of your sharps disposal container. There may be state or local laws about how you should throw away used needles, syringes, and prefilled syringes. For more information about safe sharps disposal, and for specific information about sharps disposal in the state that you live in, go to the FDA's website at:

<http://www.fda.gov/safesharpsdisposal>.

Manufactured by:
Novartis Pharmaceuticals Corporation
East Hanover, New Jersey 07936

US License Number 1244

© Novartis

This Instructions for Use has been approved by the U.S. Food and Drug Administration.

T2023-42

Figure J

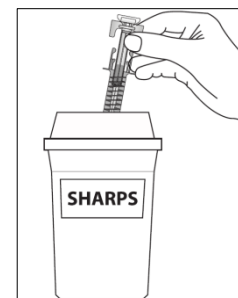

Issued: July 2023

INSTRUCTIONS FOR USE

COSENTYX® [koe-sen-tix]

(secukinumab)

injection, for subcutaneous use

150 mg/mL single-dose prefilled syringe

Be sure that you read, understand, and follow this Instructions for Use before injecting COSENTYX. Your healthcare provider should show you how to prepare and inject COSENTYX properly using the prefilled syringe before you use it for the first time. Children should not inject COSENTYX themselves using the prefilled syringe. An adult caregiver should prepare and inject COSENTYX after receiving proper training in subcutaneous injection technique. Talk to your healthcare provider if you have any questions.

Important Information You Need to Know Before Injecting COSENTYX:

- **Do not use** the COSENTYX prefilled syringe if either the seal on the outside carton or the seal of the blister are broken. Keep the COSENTYX prefilled syringe in the sealed carton until you are ready to use it.
- **Do not use** the COSENTYX prefilled syringe if the syringe has been dropped onto a hard surface or dropped after removing the needle cap.
- **Do not shake** the COSENTYX prefilled syringe.
- **The needle caps of the prefilled syringes contain latex. Do not handle the prefilled syringes if you are sensitive to latex.**
- The prefilled syringe has a needle guard that will be activated to cover the needle after the injection is finished. The needle guard will help to prevent needle stick injuries to anyone who handles the prefilled syringe.
- **Do not** remove the needle cap until just before you give the injection.
- Avoid touching the syringe guard wings before use. Touching them may cause the syringe guard to be activated too early.
- Throw away (dispose of) the used COSENTYX prefilled syringe right away after use. **Do not re-use the COSENTYX prefilled syringe.** See “How should I dispose of used COSENTYX prefilled syringes?” at the end of this Instructions for Use.

How should I store COSENTYX?

- Store your carton of COSENTYX prefilled syringes in a refrigerator, between 36°F to 46°F (2°C to 8°C).
- Keep the COSENTYX prefilled syringes in the original carton until ready to use to protect from light.
- The COSENTYX prefilled syringes may be stored at room temperature, up to 86°F (30°C), for up to 4 days.
- Write the date the COSENTYX prefilled syringes were removed from and returned to the refrigerator in the space provided on the carton.
- Throw away the COSENTYX prefilled syringe if it has been kept outside of the refrigerator over 4 days.
- COSENTYX prefilled syringe may be returned to the refrigerator **only 1 time** and must be stored between 36°F to 46°F (2°C to 8°C) until you use it or until it expires.
- **Do not** freeze the COSENTYX prefilled syringes.
- Throw away (dispose of) any expired or unused COSENTYX prefilled syringes.

Keep COSENTYX and all medicines out of the reach of children.

COSENTYX prefilled syringe parts (see Figure A):

Figure A

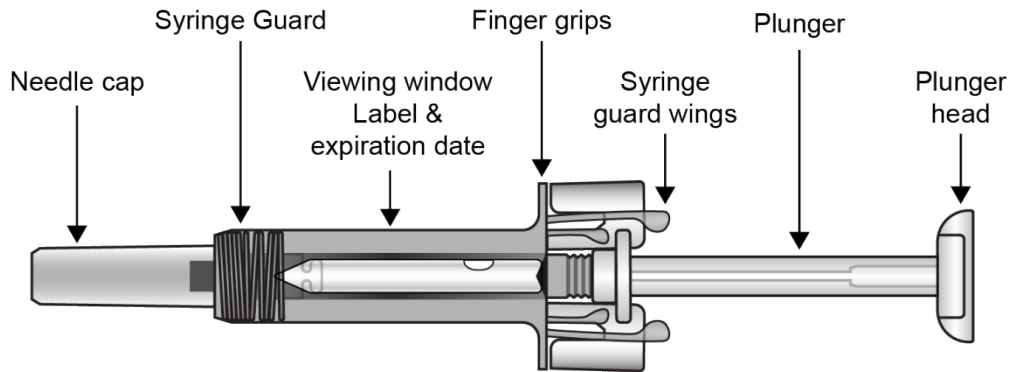

What you need for your injection:

Included in the carton:

A new COSENTYX prefilled syringe.

Each COSENTYX prefilled syringe contains **150 mg** of COSENTYX. Check to make sure that you have the correct medicine and dose.

- If your **prescribed dose** of COSENTYX is **150 mg**, you must give **1 injection**.
- If your **prescribed dose** of COSENTYX is **300 mg**, you must give **2 injections**.

Not included in the carton (see Figure B):

- 1 Alcohol wipe
- 1 Cotton ball or gauze
- Sharps disposal container

See “**How should I dispose of used COSENTYX prefilled syringes?**” at the end of this Instructions for Use.

Prepare the COSENTYX 150 mg prefilled syringe

Step 1. Find a clean, well-lit, flat work surface.

Step 2. Take the carton containing the COSENTYX prefilled syringe out of the refrigerator and leave it **unopened** on your work surface for about 15 to 30 minutes so that it reaches room temperature.

Step 3. Wash your hands well with soap and water.

Step 4. Remove the COSENTYX prefilled syringe from the outer carton and take it out of the blister.

Step 5. Look through the viewing window on the COSENTYX prefilled syringe. The liquid inside should be clear. The color may be colorless to slightly yellow. You may see a small air bubble in the liquid. This is normal. **Do not use** the prefilled syringe if the liquid contains visible particles, or if the liquid is cloudy or discolored.

Step 6. Do not use the COSENTYX prefilled syringe if it is broken. Return the prefilled syringe and the package it came in to the pharmacy.

Step 7. Do not use the COSENTYX prefilled syringe if the expiration date has passed.

Figure B

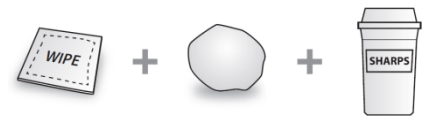

Choose and clean the injection site

- Areas of your body that you may use as injection sites include:
 - the front of your thighs (**see Figure C**)
 - the lower stomach-area (abdomen), but **not** the area 2 inches around your navel (belly button) (**see Figure C**)
 - the upper outer arms, if a caregiver or healthcare provider is giving you the injection (**see Figure D**)
- Choose a different site for each injection of COSENTYX.
- **Do not** inject into areas where the skin is tender, bruised, red, scaly, or hard, or in an area of skin that is affected by psoriasis. Avoid areas with scars or stretch marks.

Step 8. Using a circular motion, clean the injection site with the alcohol wipe. Leave it to dry before injecting. **Do not** touch the cleaned area again before injecting.

Figure C

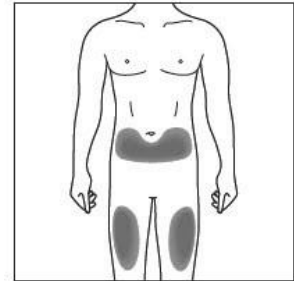
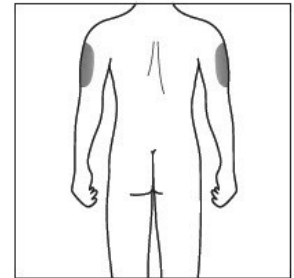

Figure D



Giving the injection

Step 9. Carefully remove the needle cap from the COSENTYX prefilled syringe (**see Figure E**). Throw away the needle cap. You may see a drop of liquid at the end of the needle. This is normal.

Figure E

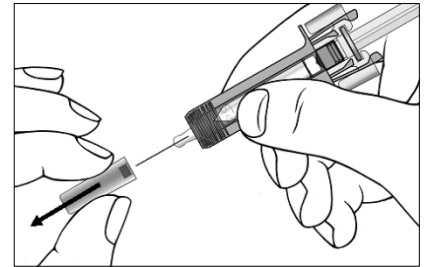

Step 10. With one hand gently pinch the skin at the injection site. With your other hand insert the needle into your skin at a 45-degree angle as shown (**see Figure F**). Push the needle all the way in to make sure that you inject your full dose.

Figure F

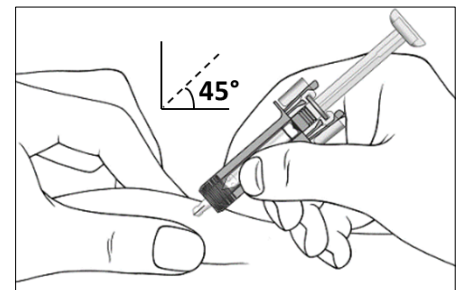

Step 11. Hold the COSENTYX prefilled syringe finger grips as shown (see **Figure G**). Slowly press down on the plunger as far as it will go, so that the plunger head is completely between the syringe guard wings. This will make sure that the syringe guard has been activated.

Step 12. Continue to press fully on the plunger for an additional 5 seconds. Hold the syringe in place for the full 5 seconds.

Figure G

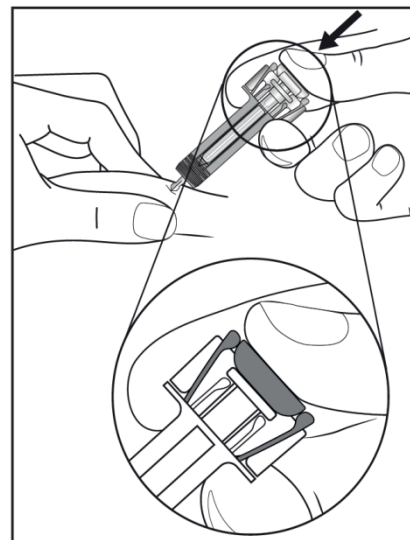

Step 13. Keep the plunger fully depressed while you carefully pull the needle straight out from the injection site (see **Figure H**).

Figure H

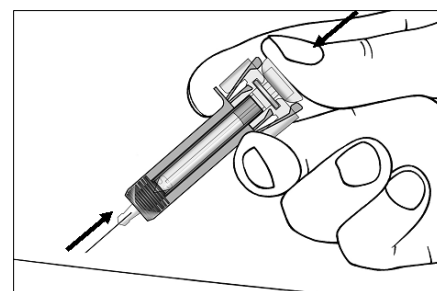

Step 14. Slowly release the plunger and allow the syringe guard to automatically cover the exposed needle (see **Figure I**).

Figure I

Step 15. There may be a small amount of blood at the injection site. You can press a cotton ball or gauze over the injection site and hold it for 10 seconds. **Do not** rub the injection site. You may cover the injection site with a small adhesive bandage, if needed.

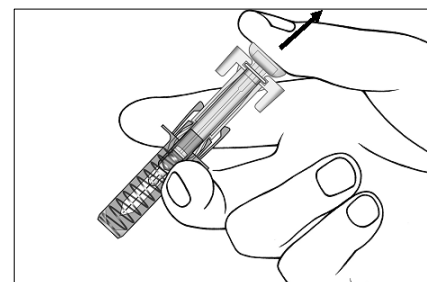

If your prescribed dose of COSENTYX is 300 mg, repeat Steps 4 through 15 with a new COSENTYX prefilled syringe.

How should I dispose of used COSENTYX prefilled syringes?

Step 16. Put your used prefilled syringes in an FDA-cleared sharps disposal container right away after use (**see Figure J**). **Do not throw away (dispose of)** the prefilled syringes in your household trash.

If you do not have an FDA-cleared sharps disposal container, you may use a household container that is:

- made of a heavy-duty plastic,
- can be closed with a tight-fitting, puncture-resistant lid, without sharps being able to come out,
- upright and stable during use,
- leak-resistant, and
- properly labeled to warn of hazardous waste inside the container.

When your sharps disposal container is almost full, you will need to follow your community guidelines for the right way to dispose of your sharps disposal container. There may be state or local laws about how you should throw away used needles, syringes, and prefilled syringes. For more information about safe sharps disposal, and for specific information about sharps disposal in the state that you live in, go to the FDA's website at:

<http://www.fda.gov/safesharpsdisposal>.

Manufactured by:
Novartis Pharmaceuticals Corporation
East Hanover, New Jersey 07936

US License Number 1244

© Novartis

This Instructions for Use has been approved by the U.S. Food and Drug Administration.

T2023-43

Figure J

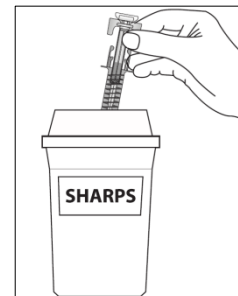

Revised: July 2023

INSTRUCTIONS FOR USE

COSENTYX® [koe-sen-tix]

(secukinumab)

injection, for subcutaneous use

75 mg/0.5 mL single-dose prefilled syringe

Be sure that you read, understand, and follow this Instructions for Use before injecting COSENTYX. Your healthcare provider should show you how to prepare and inject COSENTYX properly using the prefilled syringe before you use it for the first time. Children should not inject COSENTYX themselves using the prefilled syringe. An adult caregiver should prepare and inject COSENTYX after receiving proper training in subcutaneous injection technique. Talk to your healthcare provider if you have any questions.

Important Information You Need to Know Before Injecting COSENTYX:

- **Do not use** the COSENTYX prefilled syringe if either the seal on the outside carton or the seal of the blister are broken. Keep the COSENTYX prefilled syringe in the sealed carton until you are ready to use it.
- **Do not use** the COSENTYX prefilled syringe if the syringe has been dropped onto a hard surface or dropped after removing the needle cap.
- **Do not shake** the COSENTYX prefilled syringe.
- **The needle cap of the prefilled syringe contains latex. Do not handle the prefilled syringe if you are sensitive to latex.**
- The prefilled syringe has a needle guard that will be activated to cover the needle after the injection is finished. The needle guard will help to prevent needle stick injuries to anyone who handles the prefilled syringe.
- **Do not** remove the needle cap until just before you give the injection.
- Avoid touching the syringe guard wings before use. Touching them may cause the syringe guard to be activated too early.
- Throw away (dispose of) the used COSENTYX prefilled syringe right away after use. **Do not re-use the COSENTYX prefilled syringe.** See “How should I dispose of the used COSENTYX prefilled syringe?” at the end of this Instructions for Use.

How should I store COSENTYX?

- Store your carton of COSENTYX prefilled syringe in a refrigerator, between 36°F to 46°F (2°C to 8°C).
- Keep the COSENTYX prefilled syringe in the original carton until ready to use to protect from light.
- COSENTYX prefilled syringe may be stored at room temperature, up to 86°F (30°C), for up to 4 days.
- Write the date COSENTYX prefilled syringe was removed from and returned to the refrigerator in the space provided on the carton.
- Throw away COSENTYX prefilled syringe if it has been kept outside of the refrigerator over 4 days.
- COSENTYX prefilled syringe may be returned to the refrigerator only 1 time and must be stored between 36°F to 46°F (2°C to 8°C) until you use it or until it expires.
- **Do not freeze** the COSENTYX prefilled syringe.
- Throw away (dispose of) any expired or unused COSENTYX prefilled syringe.

Keep COSENTYX and all medicines out of the reach of children.

COSENTYX prefilled syringe parts (see Figure A):

Figure A

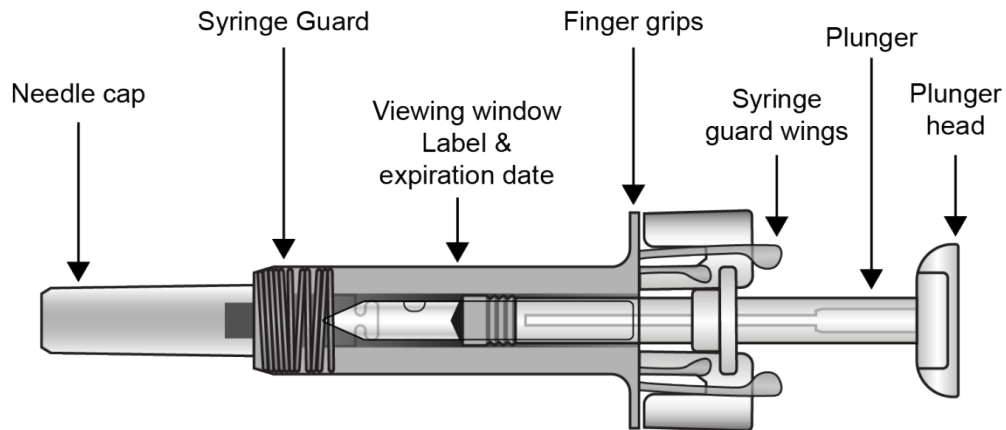

What you need for your injection:

Included in the carton:

A new COSENTYX prefilled syringe.

Each COSENTYX prefilled syringe contains **75 mg** of COSENTYX. Check to make sure that you have the correct medicine and dose.

Not included in the carton (see Figure B):

- 1 Alcohol wipe
- 1 Cotton ball or gauze
- Sharps disposal container

See “**How should I dispose of the used COSENTYX prefilled syringe?**” at the end of this Instructions for Use.

Figure B

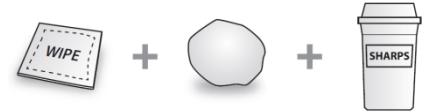

Prepare the COSENTYX 75 mg prefilled syringe

Step 1. Find a clean, well-lit, flat work surface.

Step 2. Take the carton containing the COSENTYX prefilled syringe out of the refrigerator and leave it **unopened** on your work surface for about 15 to 30 minutes so that it reaches room temperature.

Step 3. Wash your hands well with soap and water.

Step 4. Remove the COSENTYX prefilled syringe from the outer carton and take it out of the blister.

Step 5. Look through the viewing window on the COSENTYX prefilled syringe. The liquid inside should be clear. The color may be colorless to slightly yellow. You may see a small air bubble in the liquid. This is normal. **Do not use** the prefilled syringe if the liquid contains visible particles, or if the liquid is cloudy or discolored.

Step 6. Do not use the COSENTYX prefilled syringe if it is broken. Return the prefilled syringe and the package it came in to the pharmacy.

Step 7. Do not use the COSENTYX prefilled syringe if the expiration date has passed.

Choose and clean the injection site

- Areas of your body that you may use as injection sites include:
 - the front of your thighs (**see Figure C**)
 - the lower stomach-area (abdomen), but **not** the area 2 inches around your navel (belly button) (**see Figure C**)
 - the upper outer arms (**see Figure D**)
- Choose a different site for each injection of COSENTYX.
- **Do not** inject into areas where the skin is tender, bruised, red, scaly, or hard, or in an area of skin that is affected by psoriasis. Avoid areas with scars or stretch marks.

Step 8. Using a circular motion, clean the injection site with the alcohol wipe. Leave it to dry before injecting. **Do not** touch the cleaned area again before injecting.

Figure C

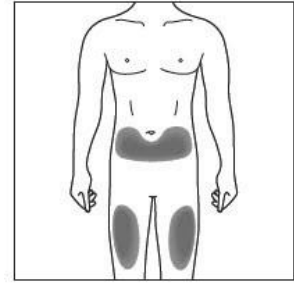
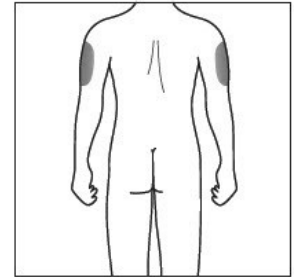

Figure D



Giving the injection

Step 9. Carefully remove the needle cap from the COSENTYX prefilled syringe (**see Figure E**). Throw away the needle cap. You may see a drop of liquid at the end of the needle. This is normal.

Figure E

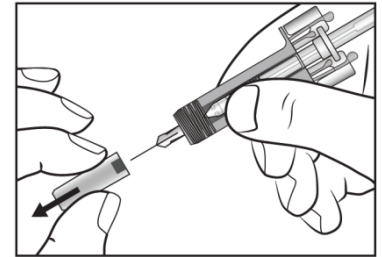

Step 10. With one hand gently pinch the skin at the injection site. With your other hand insert the needle into your skin at a 45-degree angle as shown (**see Figure F**). Push the needle all the way in to make sure that you inject your full dose.

Figure F

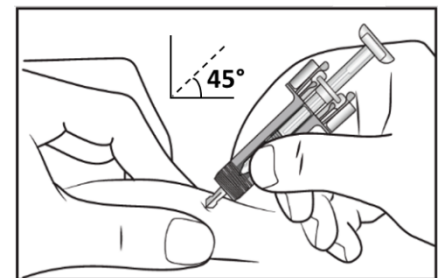

Step 11. Hold the COSENTYX prefilled syringe finger grips as shown (see **Figure G**). Slowly press down on the plunger as far as it will go, so that the plunger head is completely between the syringe guard wings. This will make sure that the syringe guard has been activated.

Step 12. Continue to press fully on the plunger for an additional 5 seconds. Hold the syringe in place for the full 5 seconds.

Figure G

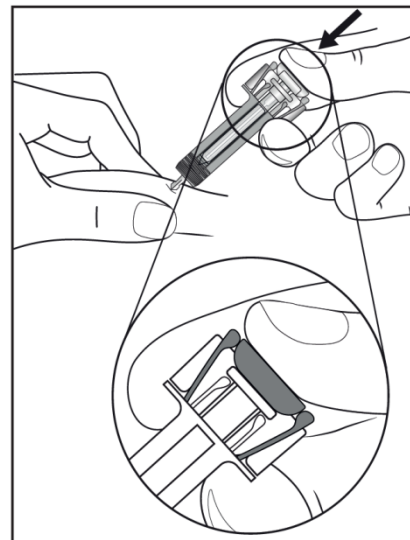

Step 13. Keep the plunger fully depressed while you carefully pull the needle straight out from the injection site (see **Figure H**).

Figure H

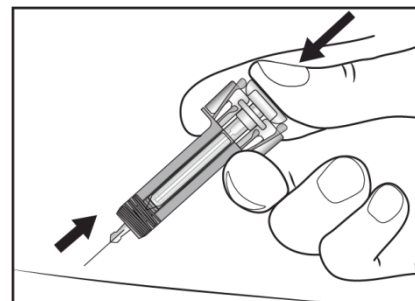

Step 14. Slowly release the plunger and allow the syringe guard to automatically cover the exposed needle (see **Figure I**).

Figure I

Step 15. There may be a small amount of blood at the injection site. You can press a cotton ball or gauze over the injection site and hold it for 10 seconds. **Do not** rub the injection site. You may cover the injection site with a small adhesive bandage, if needed.

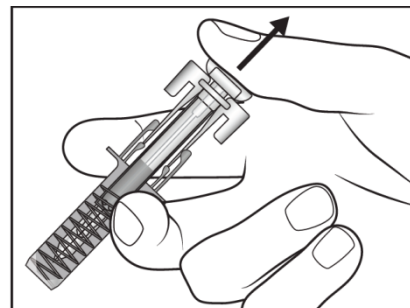

How should I dispose of the used COSENTYX prefilled syringe?

Step 16. Put your used prefilled syringe in an FDA-cleared sharps disposal container right away after use (see **Figure J**). **Do not throw away (dispose of)** the prefilled syringe in your household trash.

If you do not have an FDA-cleared sharps disposal container, you may use a household container that is:

- made of a heavy-duty plastic,
- can be closed with a tight-fitting, puncture-resistant lid, without sharps being able to come out,
- upright and stable during use,
- leak-resistant, and
- properly labeled to warn of hazardous waste inside the container.

When your sharps disposal container is almost full, you will need to follow your community guidelines for the right way to dispose of your sharps disposal container. There may be state or local laws about how you should throw away used needles, syringes, and prefilled syringes. For more information about safe sharps disposal, and for specific information about sharps disposal in the state that you live in, go to the FDA's website at:

<http://www.fda.gov/safesharpsdisposal>.

Manufactured by:
Novartis Pharmaceuticals Corporation
East Hanover, New Jersey 07936

US License Number 1244

© Novartis

This Instructions for Use has been approved by the U.S. Food and Drug Administration.

T2023-44

Figure J

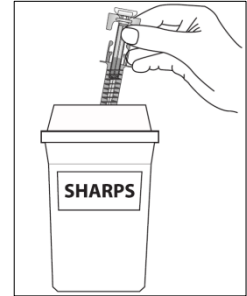

Revised: July 2023

INSTRUCTIONS FOR USE
COSENTYX® [koe-sen-tix]
(secukinumab)
injection, for subcutaneous use
300 mg/2 mL single-dose UnoReady® pen

Be sure that you read, understand, and follow this Instructions for Use before injecting COSENTYX. Your healthcare provider should show you how to prepare and properly inject with the COSENTYX UnoReady pen before you use it for the first time. Talk to your healthcare provider if you have any questions.

Cosentyx UnoReady pen parts

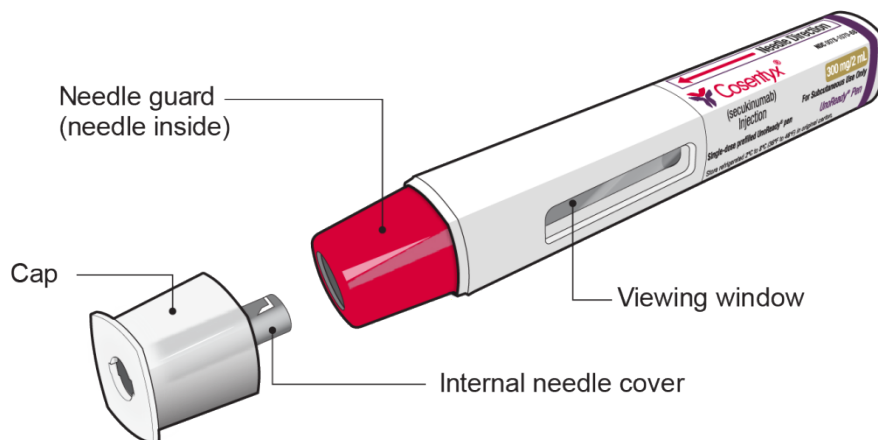

Figure A

The COSENTYX UnoReady pen is shown in **Figure A** with the cap removed.

Do not remove the cap until you are ready to inject.

Important information You Need to Know Before Injecting COSENTYX:

- **Do not** use the COSENTYX UnoReady pen if the seal on the outer carton is broken. Keep the COSENTYX UnoReady pen in the sealed outer carton until you are ready to use it.
- **Do not** shake the COSENTYX UnoReady pen.
- If you drop your COSENTYX UnoReady pen, **do not** use it if it looks damaged, or if you dropped it with the cap removed.
- The needle is covered by the needle guard and the needle will not be seen. **Do not** touch or push the needle guard because you could get a needle stick.
- Throw away (dispose of) the used COSENTYX UnoReady pen right away after use.
- **Do not** re-use the COSENTYX UnoReady pen. See “**Step 9. Disposing of the used COSENTYX UnoReady pen**” at the end of this Instructions for Use.

Storing the COSENTYX UnoReady pen

- Store your carton of COSENTYX UnoReady pen in a refrigerator between 36°F and 46°F (2°C and 8°C).
- Keep the COSENTYX UnoReady pen in the original carton until ready to use to protect from light.
- **Do not** freeze the COSENTYX UnoReady pen.
- Throw away (dispose of) any expired or unused COSENTYX UnoReady pen.

Keep the COSENTYX UnoReady pen and all medicines out of the reach of children.

What you need for your injection

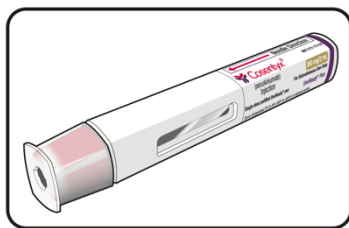

Figure B

Included in the carton (see Figure B)

- A new COSENTYX UnoReady pen
- Each COSENTYX UnoReady pen contains 300 mg of COSENTYX.** Check to make sure that you have the correct medicine and dose.

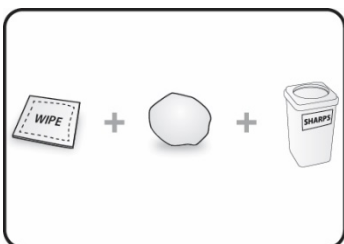

Figure C

Not included in the carton (see Figure C)

- 1 Alcohol wipe
- 1 Cotton ball or gauze
- Sharps disposal container. See “**Step 9. Disposing of the used COSENTYX UnoReady pen**” at the end of this Instructions for Use.

Prepare to inject

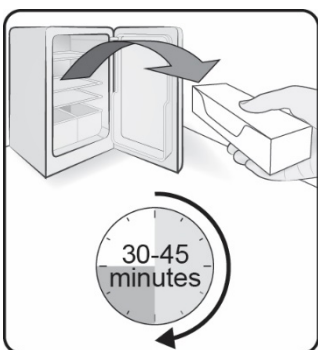

Figure D

Step 1. Bring to room temperature

Take the carton containing the COSENTYX UnoReady pen out of the refrigerator (see Figure D) and leave it **unopened for 30 to 45 minutes before injecting** to allow it to reach room temperature.

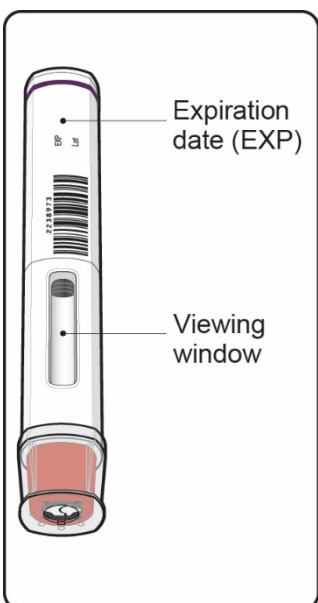

Figure E

Step 2. Important safety checks before you inject (see Figure E)

- Look at the expiration date (**EXP**) on your COSENTYX UnoReady pen. **Do not** use the COSENTYX UnoReady pen if the expiration date has passed.
- Look through the viewing window. The liquid should be clear. Its color may vary from colorless to slightly yellow.
- **Do not** use if the liquid contains visible particles, is cloudy or is discolored. You may see air bubbles, which is normal.

Contact your healthcare provider or pharmacist if the COSENTYX UnoReady pen fails any of these checks.

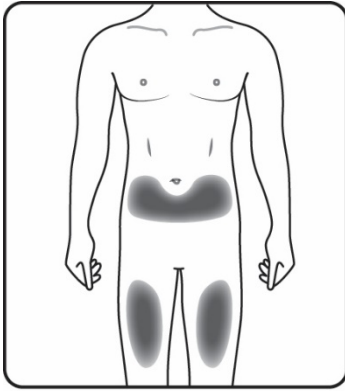

Figure F

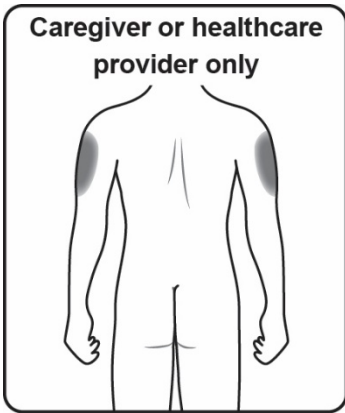

Figure G



Figure H

Injecting with the COSENTYX UnoReady pen

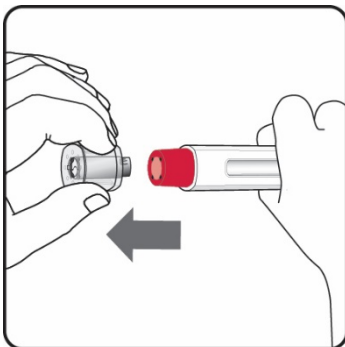

Figure I

Step 3. Choose the injection site

- The recommended site is the front of the thighs. You may also use the lower abdomen, but **not** the area 2 inches around the navel (belly button) (see Figure F).
- Choose a different site each time you give an injection.
- **Do not** inject into areas where the skin is tender, bruised, red, scaly, or hard or in an area of skin that is affected by psoriasis. Avoid areas with scars or stretch marks.

- If a **caregiver** or **healthcare provider** is giving you your injection, they may also inject into your outer upper arm (see Figure G).

Step 4. Clean the injection site

- Wash your hands well with soap and water.
- Using a circular motion, clean the injection site with the alcohol wipe (see Figure H). Leave it to dry before injecting.
- **Do not** touch the cleaned area again before injecting.

Step 5. Remove the cap

- Only remove the cap when you are ready to use the COSENTYX UnoReady pen.
- **Pull** the cap straight off (see Figure I). **Do not** twist the cap.
- Throw away the cap. **Do not** try to re-attach the cap.
- Use the COSENTYX UnoReady pen within 5 minutes of removing the cap.

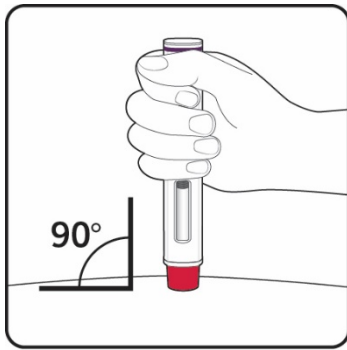
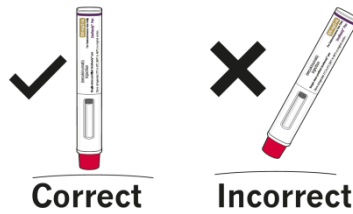

Figure J

Step 6. Position the COSENTYX UnoReady pen

Hold the COSENTYX UnoReady pen at 90 degrees against the cleaned injection site with the viewing window facing you (see Figure J).



Step 7. Injecting with the COSENTYX UnoReady pen as described below (see Figure K)

	<p>HOLD</p>		<p>HOLD</p>	<p>After the 2nd click, continue to hold down and slowly count to 5</p>	<p>HOLD</p>	
<p>Start the injection</p> <ul style="list-style-type: none"> • Press and hold the COSENTYX UnoReady pen firmly against the skin to start the injection. • The 1st click indicates the injection has started. • Keep holding the COSENTYX UnoReady pen firmly against your skin after the 1st click. 	<p>Monitor the injection</p> <ul style="list-style-type: none"> • The green indicator will move within the viewing window. • The 2nd click indicates the injection is almost complete. • Keep holding the COSENTYX UnoReady pen firmly against your skin after the 2nd click. 	<ul style="list-style-type: none"> • Keep holding the COSENTYX UnoReady pen firmly against your skin and slowly count to 5. 	<p>Complete the injection</p> <ul style="list-style-type: none"> • Check that the green indicator with a grey tip has stopped moving. • The COSENTYX UnoReady pen can now be removed from your skin. 			

Figure K

After the injection

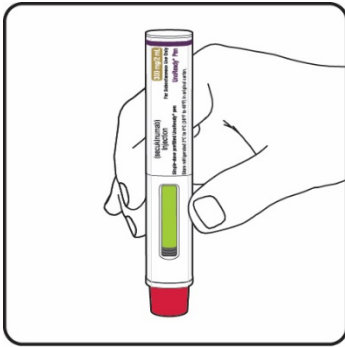

Figure L

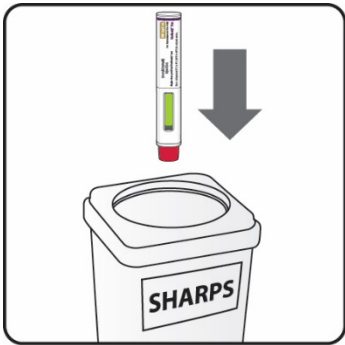

Figure M

Step 8. Check that the green indicator has filled the window (see Figure L)

- This means the medicine has been delivered. Contact your healthcare provider or pharmacist if the green indicator is not visible or does not fill the window.
- There may be a small amount of blood at the injection site. You can press a cotton ball or gauze over the injection site and hold it for a few seconds. **Do not** rub the injection site. You may cover the injection site with a small adhesive bandage, if needed.

Step 9. Disposing of the used COSENTYX UnoReady pen

- Put your used COSENTYX UnoReady pen in an FDA-cleared sharps disposal container right away after use (see Figure M). **Do not throw away (dispose of)** the COSENTYX UnoReady pen in your household trash. If you do not have an FDA-cleared sharps disposal container, you may use a household container that is:
 - made of a heavy-duty plastic,
 - can be closed with a tight-fitting, puncture-resistant lid, without sharps being able to come out,
 - upright and stable during use,
 - leak-resistant, and
 - properly labeled to warn of hazardous waste inside the container.
- When your sharps disposal container is almost full, you will need to follow your community guidelines for the right way to dispose of your sharps disposal container. There may be state or local laws about how you should throw away used needles, syringes, and COSENTYX UnoReady pens.

For more information about safe sharps disposal, and for specific information about sharps disposal in the state that you live in, go to the FDA's website at: <http://www.fda.gov/safesharpsdisposal>.

Manufactured by:
Novartis Pharmaceuticals Corporation
East Hanover, New Jersey 07936

US License Number 1244

© Novartis

This Instructions for Use has been approved by the U.S. Food and Drug Administration.

Issued: July 2023

T2023-45

INSTRUCTIONS FOR USE
COSENTYX® [koe-sen-tix]
(secukinumab)
injection, for subcutaneous use
150 mg/mL single-dose Sensoready® pen

Be sure that you read, understand, and follow this Instructions for Use before injecting COSENTYX. Your healthcare provider should show you how to prepare and inject COSENTYX properly using the Sensoready pen before you use it for the first time. Children should not inject COSENTYX themselves using the Sensoready pen. An adult caregiver should prepare and inject COSENTYX after receiving proper training in subcutaneous injection technique. Talk to your healthcare provider if you have any questions.

Important Information You Need to Know Before Injecting COSENTYX:

- **Do not use** the COSENTYX Sensoready pen if either the seal on the outer carton or the seal on the pen is broken. Keep the COSENTYX Sensoready pen in the sealed outer carton until you are ready to use it.
- **Do not shake** the COSENTYX Sensoready pen.
- The caps of the Sensoready pens contain latex. **Do not handle the Sensoready pens if you are sensitive to latex.**
- If you drop your COSENTYX Sensoready pen, **do not use** it if the Sensoready pen looks damaged, or if you dropped it with the cap removed.
- Throw away (dispose of) the used COSENTYX Sensoready pen right away after use. **Do not re-use the COSENTYX Sensoready pen.** See “**How should I dispose of used COSENTYX Sensoready pens?**” at the end of this Instructions for Use.

How should I store COSENTYX?

- Store your carton of COSENTYX Sensoready pens in a refrigerator, between 36°F to 46°F (2°C to 8°C).
- Keep the COSENTYX Sensoready pens in the original carton until ready to use to protect from light.
- The COSENTYX Sensoready pens may be stored at room temperature, up to 86°F (30°C), for up to 4 days.
- Write the date the COSENTYX Sensoready pens were removed from and returned to the refrigerator in the space provided on the carton.
- Throw away the COSENTYX Sensoready pen if it has been kept outside of the refrigerator over 4 days.
- COSENTYX Sensoready pen may be returned to the refrigerator **only 1 time** and must be stored between 36°F to 46°F (2°C to 8°C) until you use it or until it expires.
- **Do not freeze** the COSENTYX Sensoready pens.
- Throw away (dispose of) any expired or unused COSENTYX Sensoready pens.

Keep COSENTYX and all medicines out of the reach of children.

COSENTYX Sensoready pen parts (see Figure A):

Figure A

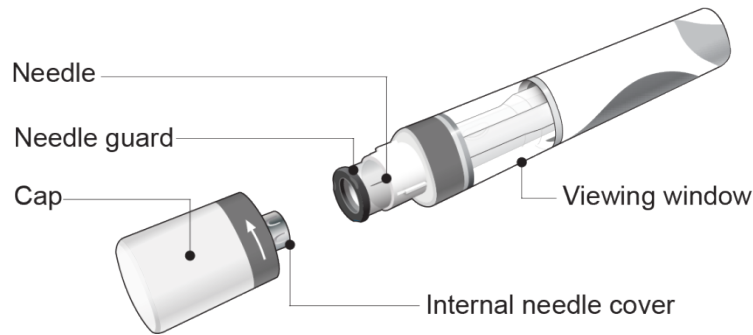

The COSENTYX Sensoready pen is shown above with the cap removed. **Do not** remove the cap until you are ready to inject.

What you need for your injection:

Included in the carton:

A new COSENTYX Sensoready pen (see Figure B).

Each COSENTYX Sensoready pen contains **150 mg** of COSENTYX. Check to make sure that you have the correct medicine and dose.

- If your **prescribed dose** of COSENTYX is **150 mg**, you must give **1 injection**.
- If your **prescribed dose** of COSENTYX is **300 mg**, you must give **2 injections**.

Not included in the carton (see Figure C):

- 1 Alcohol wipe
- 1 Cotton ball or gauze
- Sharps disposal container.

See “**How should I dispose of used COSENTYX Sensoready pens?**” at the end of this Instructions for Use.

Before your injection:

Take the carton containing the COSENTYX Sensoready pen out of the refrigerator and leave it **unopened for about 15 to 30 minutes before injecting** to allow it to reach room temperature.

Figure B

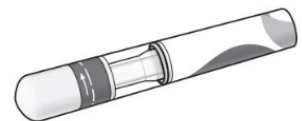
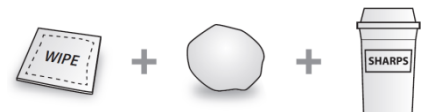

Figure C



Step 1. Important safety checks before you inject (see **Figure D**):

- Look through the viewing window. The liquid should be clear. Its color may vary from colorless to slightly yellow.
Do not use if the liquid contains visible particles, is cloudy or is discolored. You may see a small air bubble, which is normal.
- Look at the **expiration date (EXP)** on your Sensoready pen. **Do not use** your COSENTYX Sensoready pen if the expiration date has passed.

Contact your pharmacist if the COSENTYX Sensoready pen fails any of these checks.

Step 2. Choose the injection site:

- The recommended site is the front of the thighs. You may also use the lower abdomen, but **not** the area 2 inches around the navel (belly button) (see **Figure E**).
- Choose a different site each time you give an injection.
- **Do not** inject into areas where the skin is tender, bruised, red, scaly, or hard, or in an area of skin that is affected by psoriasis. Avoid areas with scars or stretch marks.
- If a **caregiver** or **healthcare provider** is giving you your injection, they may also inject into your outer upper arm (see **Figure F**).

Step 3. Cleaning the injection site:

- Wash your hands well with soap and water.
- Using a circular motion, clean the injection site with the alcohol wipe. Leave it to dry before injecting (see **Figure G**).
- **Do not** touch the cleaned area again before injecting.

Figure D

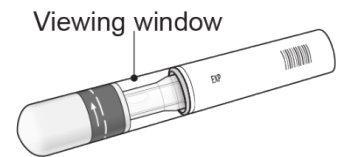

Figure E

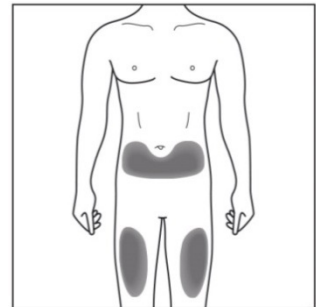

Figure F

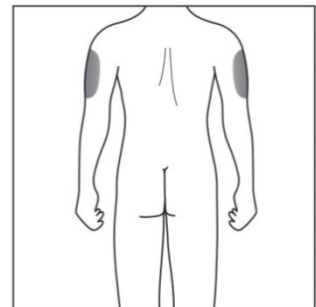
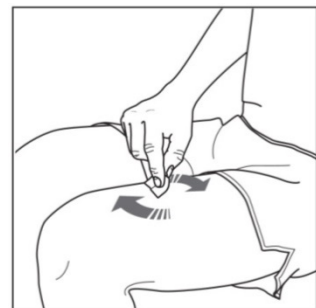

Figure G



Your injection:

Step 4. Removing the cap:

- Only remove the cap when you are ready to use the COSENTYX Sensoready pen.
- Twist off the cap in the direction of the arrow (see Figure H).
- Throw away the cap. **Do not try to re-attach the cap.**
- Use the COSENTYX Sensoready pen within 5 minutes of removing the cap.

Figure H

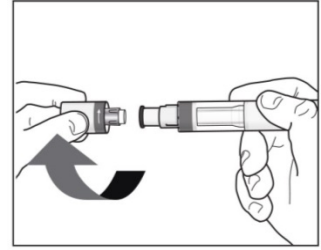

Step 5. Holding the COSENTYX Sensoready pen:

- Hold the COSENTYX Sensoready pen at 90 degrees to the cleaned injection site (see Figure I).

Figure I

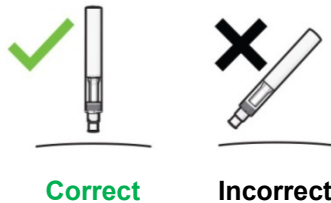
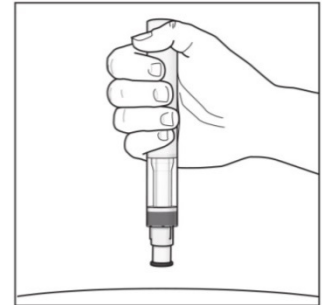

Important: During the injection you will hear 2 loud clicks:

- The **1st click** indicates that **the injection has started**.
- Several seconds later a **2nd click** will indicate that **the injection is almost finished**.

You must keep holding the COSENTYX Sensoready pen firmly against the skin until you see a **green indicator** fill the window and stop moving.

Step 6. Starting the injection:

- Press the COSENTYX Sensoready pen firmly against the skin to start the injection (see Figure J).
- The **1st click** indicates the injection has started.
- **Keep holding** the COSENTYX Sensoready pen firmly against the skin.
- The **green indicator** shows the progress of the injection.

Figure J

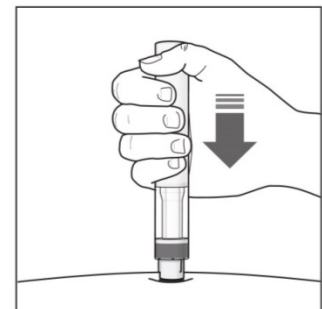

Step 7. Completing the injection:

- Listen for the **2nd click**. This indicates the injection is **almost** complete.
- Check the **green indicator** fills the window and has stopped moving (see Figure K).
- The COSENTYX Sensoready pen can now be removed.

Figure K

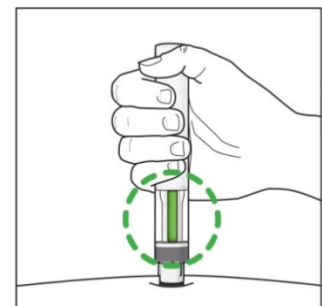

After the injection:

Step 8. Check the green indicator fills the window (see **Figure L**):

- This means the medicine has been delivered. Contact your healthcare provider if the green indicator is not visible.
- There may be a small amount of blood at the injection site. You can press a cotton ball or gauze over the injection site and hold it for 10 seconds. **Do not** rub the injection site. You may cover the injection site with a small adhesive bandage, if needed.

If your prescribed dose of COSENTYX is 300 mg, repeat Steps 1 through 8 with a new COSENTYX Sensoready pen.

How should I dispose of used COSENTYX Sensoready pens?

Step 9. Put your used Sensoready pen in an FDA-cleared sharps disposal container right away after use (see **Figure M**). **Do not throw away (dispose of)** the Sensoready pens in your household trash.

If you do not have an FDA-cleared sharps disposal container, you may use a household container that is:

- made of a heavy-duty plastic,
- can be closed with a tight-fitting, puncture-resistant lid, without sharps being able to come out,
- upright and stable during use,
- leak-resistant, and
- properly labeled to warn of hazardous waste inside the container.

When your sharps disposal container is almost full, you will need to follow your community guidelines for the right way to dispose of your sharps disposal container. There may be state or local laws about how you should throw away used needles, syringes, and Sensoready pens. For more information about safe sharps disposal, and for specific information about sharps disposal in the state that you live in, go to the FDA's website at: <http://www.fda.gov/safesharpsdisposal>.

Manufactured by:
Novartis Pharmaceuticals Corporation
East Hanover, New Jersey 07936

US License Number 1244

© Novartis

This Instructions for Use has been approved by the U.S. Food and Drug Administration.

T2023-46

Figure L

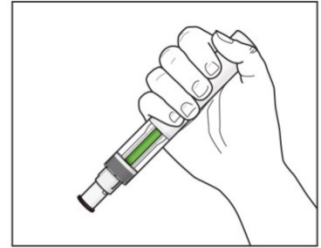
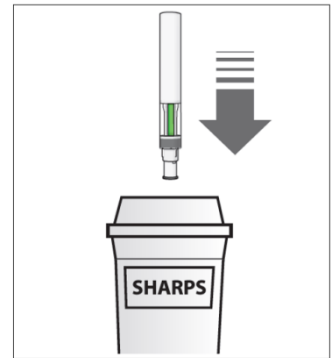

Figure M



Revised: July 2023